

WDR Table of Contents

Introduction.....	1
Installation	2
Configuring the WDR Reader	8
Scanning Techniques	9
Using The WDR Setup Menu	10
Test the Reader with your computer	24
Using the Bar Code Slot Scanner	25
Using the MagStripe Slot Scanner	26
Laser and CCD Scanners.....	27
Accumulate Mode	31
Function/Control Key Support.....	32
Polling.....	33
Troubleshooting	37
WDR Reader Cables and Pinouts	40
Opening the WDR Case.....	42
Jumper & Switch Settings	43
Specifications for Code 39	45
Codabar Specifications	48
Code 128 Specifications	49
Interleaved 2 of 5 Code.....	51
UPC Specifications	53
MSI/Plessey Specifications	57
Code 93 Specifications	59
PC Terminal Mode	60
WDR Setup Menu	62
Index.....	69

06/06

© Copyright 2006, Worth Data, Inc.

Introduction

Worth Data's **WDR Readers** are versatile serial bar code readers designed for use with all micro and minicomputers. Features of the WDR Reader include:

- The WDR Model R22 can be attached between your computer and a terminal, sending bar code data along with keyboard data with LINUX, UNIX and PICK.
- Up to 32 WDR R22 Readers can be connected to a dedicated serial port, with each unit accessed separately through polling from your computer.
- The R22 WDR can be ordered a variety of scanners including:
 - Hand-held laser scanners,
 - CCD Scanner.
 - Bar code slot badge or wand scanner, and
 - MagStripe scanners,
- The WDR Reader automatically reads and discriminates between Code 39, Full ASCII Code 39, 2 of 5, I 2 of 5, UPC-E, UPC-A, EAN-8, EAN-13, Codabar, Code 93, MSI, Plessey, RSS-14, LabelCode 4&5, StorageTek Tape Code, Code 128, UCC-128, and EAN-128.
- The WDR Reader is easily configured for your system by scanning menu setup bar codes. For almost all applications no switch setting or opening of the reader's case is required.

If you are installing the WDR Reader on a dedicated PC serial port (as opposed to installing it between a PC serial port and a terminal) you should consider Worth Data's program **PortKey**.

PortKey is a Windows program that automatically takes bar code data from the serial port and places it into your PC's keyboard buffer, making the WDR the functional equivalent of a "wedge" type reader. Otherwise, you must explicitly read the serial port as a separate device. PortKey also has the capability of automatic *background* data collection from 1 to 32 WDR Readers. As you use your Windows System for word processing, spreadsheets or any other application programs, PortKey runs transparently in the background, collecting data from your WDR readers, time and date-stamping the data, and storing it on your hard disk.

Installation

Components of WDR Reader:

The contents of your WDR Reader shipment should include the following:

- 1) A WDR R22 decoder box plus:
 - a. Velcro strips which can be used to conveniently attach the reader to the side of your computer, monitor or desk.
 - b. If ordered, one of the appropriate serial Cable Selections:
 - F34 null-modem female DB-25 cable
 - F36 straight-through female DB-9 cable
 - F45-1 serial “Y” cable for connection between terminal and host

(See page 42 for pin-outs and longer descriptions)
 - c. A scanner (F52 wand, LI50 CCD, LZ300 Laser or LZ400 Laser)
 - d. A scanner holder.
 - e. A 5-volt power supply (**Don't use a non-Worth Data power supply; it will fry the board!**).
 - f. A laminated Reader Setup Menu sheet (or slot scanner card deck)
 - g. A CD-ROM with the Windows WDR Test Program on it.

Connect the scanner to the WDR Reader:

Insert the scanner's telephone-style connector into the WDR Reader's scanner port. You'll hear a click when it is properly inserted. (If you have a MagStripe slot scanner, see page 27 for its installation instructions.)

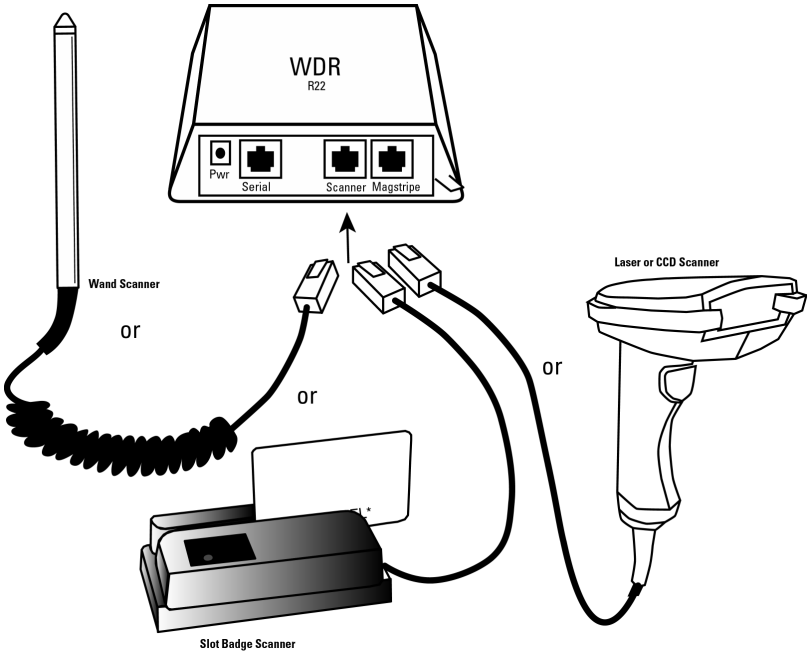

Connect the power adapter to the WDR Reader & to an outlet:

Be certain to only use a Worth Data power supply; any other power supply will likely fry the reader. Insert the power jack into the WDR Reader's power connector, and plug the other end into an electric outlet. You'll hear three beeps as the reader performs its self-test, and the LED will flash red to green.

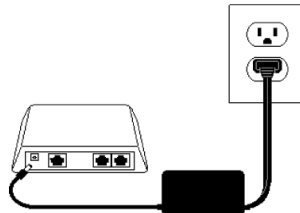

Installing the WDR Reader with a dedicated serial port

The WDR Reader can be directly attached to a spare serial port as shown below. Your software will need to read the serial port as a separate device, unless you're using an IBM-compatible computer and Worth Data's **PortKey** software, which makes serial-port data look to your computer as if it had been typed at the keyboard.

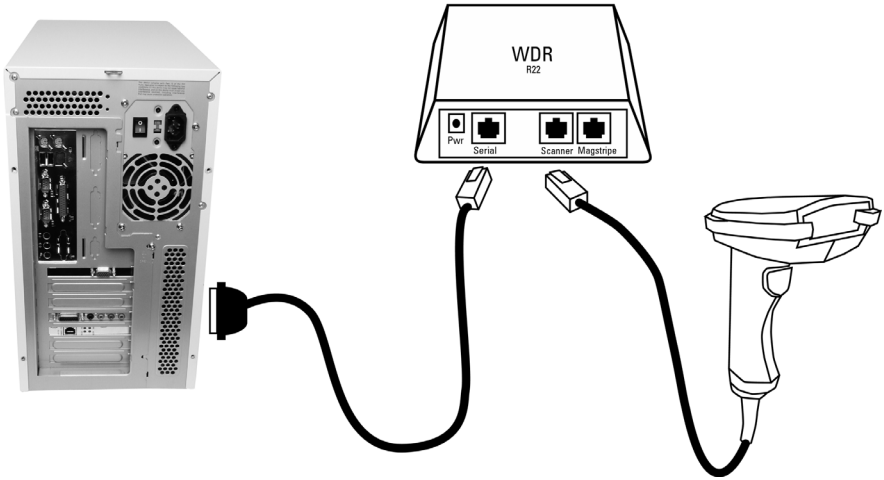

If you specified a 25-pin null-modem cable (part number F34) or a 9-pin cable (part number F36) when you placed your order, you can cable directly from the “**SERIAL**” port to the matching serial port on your computer.

Installing the WDR Reader between a Host and Terminal

If you attach the WDR R22 Reader between your computer and a terminal, as shown below, using the F45-1 Serial Y Cable, bar code data will display on the terminal as if it had been typed.

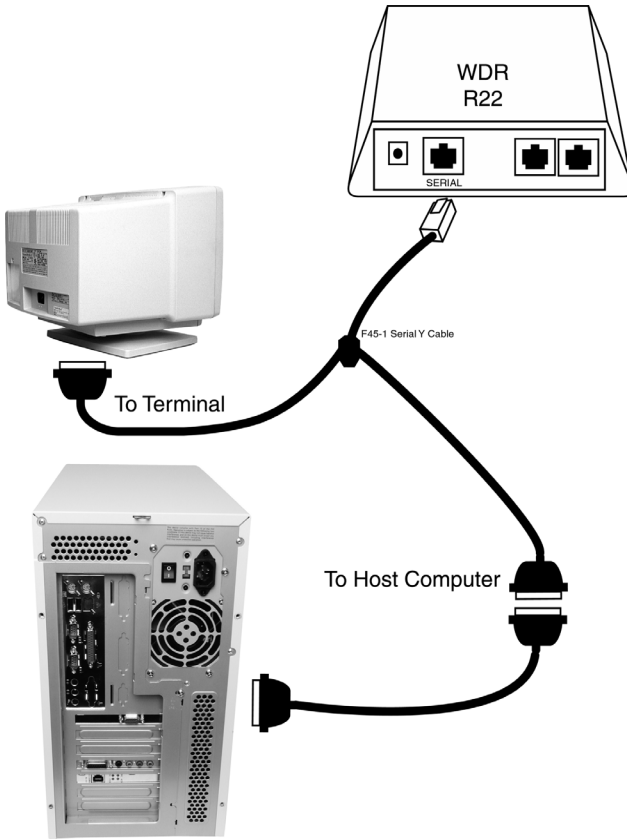

The F45-1 Serial Y Cable assumes you already have a dumb ASCII terminal connected to a host computer. Unplug the host cable from the terminal and plug it into the DB25 Female cable end on the F45-1 cable. Connect the other 25 pin end of the F45-1 Y Cable to the terminal (where the host cable was plugged previously). The WDR R22 now sits in-between the terminal and host acting as a wedge reader; data scanned is echoed back by the host to the terminal screen.

The WDR reader must be configured so that the Baud Rate, Data Bits, Stop Bits and Parity match the settings on the terminal. You may need to consult your terminal's documentation to determine how those settings are viewed on the terminal. Once you know what the settings are, you can use the *WDR Setup Menu* to make any necessary changes.

"Daisy-Chain" Attachment

"Daisy Chaining" allows many readers to be used with a single serial port.

Each WDR R22 Reader uses one F45-1 Serial Y Cable plugged into it's SERIAL port. A straight 25pin- to-25pin serial cable is used to go from Y cable to Y cable (see the diagram below).

With three, four, or more readers, repeat this step to connect the second to the third, the third to the fourth, and so on, until all readers are "daisy-chained" together. These daisy-chain cables are straight 25 pin male-to-female serial cables that can be found in many different lengths.

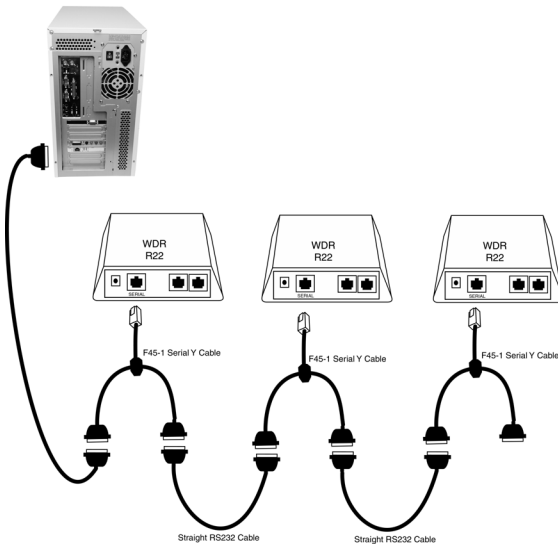

Depending upon the configuration of the serial port on your computer, you may need to rewire the DB-25 or DB-9 end of the supplied serial cable, use a "gender changer" or "null-modem adapter" (available at computer stores). See pages 42 and 43 for cable pin-outs.

Follow these instructions to connect and configure your WDR Readers for polling.

Connect the Worth Data power supplies to the WDR readers and plug the power supplies into your outlets. You should hear three beeps as each WDR Reader is plugged into the wall.

Setup each WDR Reader to the communications and bar code configuration you want to use using the bar coded **WDR Reader Setup Menu**. Each WDR Reader

must be assigned a unique ID. The IDs for a WDR Reader and any other Worth Data readers on the same port must be limited to ASCII values 96-127.

To set the ID character on a WDR reader, scan the **Start Setup** and then **Set ID Character** bar codes from the **WDR Reader Setup Menu**. On the reverse side of the Setup menu is a bar code menu **titled Full ASCII Menu**. Scan the code for the ID (ASCII 96 - 127 is the last two columns on the Full ASCII Menu) you want to give that WDR Reader, (i.e., to give the WDR Reader an ID of **a**, scan the bar code below the lower case letter **a**). Turn the sheet back over and read **End Setup**. Repeat this process for each of your WDR Readers, assigning a different ID character to each one. See page 35 for a complete discussion of polling plus sample polling programs in source BASIC.

Configuring the WDR Reader for your computer and application

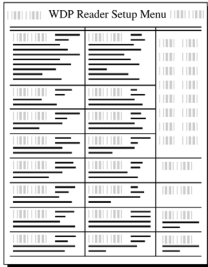

Find the 8 1/2 x 11" laminated **WDR Reader Setup Menu** sheet and look it over. This simple menu lets you easily configure the WDR Reader to work with almost any computer system, and to tailor its bar code reading and data format characteristics.

Be sure to read the scanning instructions on the next page. To read *Reader Setup Menu* bar codes and configure your reader, you must know the right way to scan bar codes.

These are the WDR Reader's default settings and are shipped configured to these settings; they can be reset to them at any time by scanning the **Start Setup** and **Reset** codes on the *Reader Setup Menu*.

- | | |
|--|-------------------------------|
| Code 39 | <u>Enabled</u> |
| Accumulate Mode enabled | Check digit disabled |
| Start/stop characters not transmitted | Caps Lock Off |
| 2 of 5 Code | <u>Disabled</u> |
| I 2 of 5 Code | <u>Disabled</u> |
| 6-digit code length | Check digit disabled |
| UPC and EAN | <u>Enabled</u> |
| UPC supplemental disabled | UPC-E Compressed and NSC of 0 |
| UPC-A NSC and EAN-13 1st 2 characters | and check digits transmitted |
| UPC-E NSC and EAN-8 1st 2 characters & | check digits not transmitted |
| Codabar | <u>Disabled</u> |
| Start/stop characters not transmitted | CLSI Format disabled |
| MSI/Plessey code | <u>Disabled</u> |
| Check digit(s) not transmitted | |
| Code 128 | <u>Enabled</u> |
| UCC/EAN-128 options enabled | |
| Code 93 | <u>Disabled</u> |
| Full ASCII disabled | |
| General configuration settings | |
| RS-232 ASCII data format | Full ASCII disabled |
| CR/LF terminating character | No ID character |
| No intercharacter delay | No MagStripe slot scanner |
| Data Transmission Timing of None | Medium Beep pitch |
| No preamble or postamble | 9600 Baud Rate |
| USA keyboard | None Parity |
| 8 Data Bits, 1 Stop Bit | Full Duplex Transmission |
| No Protocol | Host Response Disabled |
| No Aiming Dot | |

Scanning Techniques

Follow these instructions for proper scanning -- to read the *Reader Setup Menu* bar codes and configure the WDR Reader, you must know the right way to scan bar codes.

Wand scanners



Start in the white space (quiet zone) to the left or right of the bar code.



Hold the wand as if it were a pencil, with about a 30-degree tilt from perpendicular to the label. You can scan in either direction. Also, for very high density codes, the wand should be held more perpendicular to the bar code surface.

Quickly (3 to 30 inches per second) and lightly draw an imaginary line through the entire bar code. Don't go slow or press hard - neither makes it any easier to read.



Don't stop in the middle of the code. Move the wand smoothly across the entire bar code, stopping when it reaches the white space (quiet zone) to the right of the bar code.



Stay within the code throughout the entire scan. Do not move the wand's tip above or below the lines of the bar code.

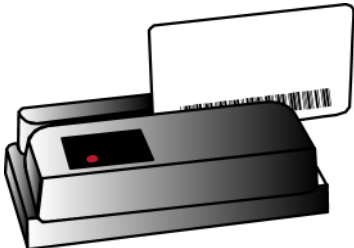

Bar code slot badge scanners

For a bar code slot scanner, take the card for the *reader setup menu* configuration bar code that you need and turn it so the bar code is facing the lighted side of the scanner. Make a continuous swiping motion through the slot in either direction.

Laser And CCD Scanning Instructions

Using a laser or CCD scanner is basically as simple and intuitive as "point and shoot" at a distance of .5 - 24", depending on the scanner and the density of the bar code.

Basically, the CCD and laser scanner's beam must cross every bar and space on the bar code, without touching any other bar codes, as shown in the first example below. For laser scanners, hold the scanner further away to produce a wider beam for large bar codes, and closer for narrower bar codes.

Even though momentary exposure to a laser's low-power, visible-light is not known to be harmful, **you should not aim the beam into anyone's eyes.**



The important thing to remember about using a laser or CCD with the WDR Reader Setup Menu is that you need to make sure the scanner's beam covers only one bar code at a time. The scanner's beam is wide enough, and the configuration bar codes close together enough, that you will need to use your fingers, or the supplied Laser Setup Assist window, to "block off" bar codes adjacent to whatever configuration bar code you need to read.



For example, to read this "5" bar code on the WDR Setup Menu, you would need to cover any adjacent bar codes with paper or a finger first, as shown.

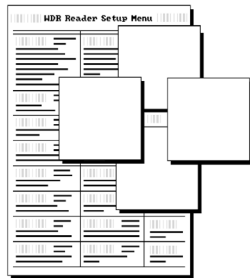

Using The WDR Setup Menu

1. To configure your reader using the **Reader Setup Menu**, you must first scan the **Start Setup** code at the top left corner (or off the setup card deck provided with slot scanners). **Do this now.** You'll hear two beeps. During Setup, nothing will be transmitted to your computer; the *Reader Setup Menu* codes are strictly for configuring the reader. If you did not hear two beeps, try scanning the code again, until you hear the two beeps. If you've never

scanned bar codes before, read the scanning instructions on pages 10-11 before continuing.

2. Next, choose the topic you want to change an option for, and scan its code. Let's use **Beep Tone**, at the lower left corner of the menu, as an example. Scan the **Beep Tone** code now. You'll hear two beeps.
3. Then, choose the option you want to change, from the list next to the topic bar code you just scanned. For **Beep Tone**, the options range from **0** for the lowest pitch to **4** for the highest pitch. Using the "Barpad Table" on the right side of the Reader Setup Menu, scan the number or letter associated with the option you have selected. Let's change the beep pitch to **Highest**. Now scan the **4** on the "Barpad Table". You will again hear two beeps.
4. Now scan End Setup (at the top-right corner of the Reader Setup Menu to complete the setup exercise. You'll hear three beeps, (on the Base Stations or 2-Way Laser). If you followed the instructions correctly and successfully changed beep tone to "highest", the three beeps will be higher in pitch than the other beeps had been. If they aren't higher in pitch, repeat the steps on this page until you are successful at changing the beep tone.

Now that your beep tone is at the "highest" pitch, you may want to change it back to "medium" or a different setting. Repeat the steps above, selecting the option you prefer to "highest" in step 3.

When you've successfully changed the beep pitch, and are ready to configure the reader for your specific application, scan **Start Setup** again. Continue scanning topics and options until you've made all the changes you desire, and then scan **End Setup** to complete setup. For keyboard models, pay attention to *Keyboard Country*, *Computer Interface*, and *Data Transmission Timing*. For serial models, pay attention to *Baud Rate*, *Parity*, and *Data Bits*.

The following pages will show you all of the configuration settings with default settings in **bold** (default settings are marked with an * on the *WDR Reader Setup Menu*).

Beep Tone

Lowest	0
Low	1
Medium	2
High	3
Highest	4
No Beep, No Laser Good LED	5
No Beep, but Laser Good LED	6
No Aiming Dot for LZ400-D	9
1 Second Aiming Dot	A
2 Second Aiming Dot	B
3 Second Aiming Dot	C
4 Second Aiming Dot	D
5 Second Aiming Dot	E
6 Second Aiming Dot	F

Code 3 of 9 (Code 39)

Enable Code 39	0
Disable Code 39	1
Enable Full ASCII Code 39	2
Disable Full ASCII Code 39	3
Enable Code 39 Accumulate Mode	4
Disable Code 39 Accumulate Mode	5
Enable Start/stop character transmission	6
Disable Start/Stop character transmission	7
Enable Mod 43 Check Digit	8
Disable Mod 43 Check Digit	9
Enable Check Digit Transmission	A
Disable Check Digit Transmission	B
Caps Lock ON	C
Caps Lock OFF	D

For information about Code 39 and Full ASCII Code 39, see Appendix D. See page 33 for information about Accumulate Mode.

Enabling Start/Stop character transmission means that the WDR Reader will transmit the * Start/Stop characters to your computer along with the data. For example, data of 1234 would be transmitted as *1234*.

Enabling the Mod 43 Check Digit requires the units position of your data to match the calculation for the check digit explained in Appendix D. *If you've enabled the check digit*, enabling Check Digit transmission causes the reader to transmit it to your computer along with the bar code data.

"Caps Lock ON" means that for all codes lower case letters read as data will be transmitted as upper case, and upper case as lower. Numbers, punctuation & control characters are not affected.

"Caps Lock OFF" means that letters will be transmitted exactly as read.

UPC/EAN

Enable UPC/EAN	0
Disable UPC/EAN	1
Enable UPC/EAN Supplements	2
Disable UPC/EAN Supplements	3
Enable transmission of UPC-A NSC and EAN-13 1st 2	4
Disable transmission of UPC-A NSC and EAN-13 1 st 1 digits	5
Enable transmission of UPC-A and EAN-13 Check Digit	6
Disable transmission of UPC-A and EAN-13 Check Digit	7
Enable transmission of UPC-E NSC and EAN-8 1 st Digit	8
Disable transmission of UPC-E NSC and EAN-8 1st Digit	9
Enable transmission of UPC-E and EAN-8 Check Digit	A
Disable transmission of UPC-E and EAN-8 check Digit	B
UPC-E Compressed	C
UPC=E Expanded	D
EAN-8 observes 9 & A above	E
EAN-8 is forced to transmit 8 digits	F
UPC-A transmitted in UPC-A format	(see below)
UPC-A transmitted in EAN-13 format	(see below)
ISBN conversion disabled	(see below)
ISBN conversion enabled	(see below)

For more information on UPC and EAN, see following page and Appendix H.

Enabling supplements allows you to read 2 and 5-digit supplemental codes used with magazines and books. **This disallows right-to-left reading** of UPC codes, to assure that the supplement doesn't get skipped. This setting also allows for reading of the *UCC/EAN 128 Extended Coupon Code*. The *Extended Coupon Code* consists of a UPC (must have NSC of 5) or an EAN (NSC of 99) code along with a Code 128 supplemental code right next to it. This setting allows you to read the Code 128 supplement as long as the correct NSC characters are present in the UPC or EAN code.

Enabling transmission of UPC's NSC or EAN country codes (leading digits, 1 for UPC; 2 for EAN-13) or Check Digits means that these digits will be transmitted to your computer along with the rest of the UPC or EAN data.

UPC-E Compressed Format transmits UPC-E codes as is; **Expanded Format** adds zeros to make them the same length as UPC-A.

UPC-E can be used in either normal UPC-E format (implicit NSC of 0) or UPC-E1 format (NSC of 1). **UPC-E1 is enabled** by wanding 2 of 5 Code and 8 (9 disables UPC-E1). It is very easy to partially read EAN-13 as UPC-E1, so **don't enable UPC-E1 if reading EAN-13**.

If you wish to **transmit UPC-A data in EAN-13 format**, (an added leading 0 for the USA's country code), wand **Terminator Character** and **F**. Wanding **E**, the default, sets UPC back to no country code transmitted.

Enable supplements to read 2 and 5-digit supplemental codes used with magazines and paperbacks. This disallows right to left reading of UPC codes, assuring that the supplement doesn't get skipped.

ISBN, International Standard Book Numbering, bar codes are EAN-13 codes with a 5 digit supplement. If the first three digits are the "Bookland" country codes of 978 for books or 977 for periodicals, then you can enable transmission of EAN-13 bar codes in the ISBN format. Suppose you scan an EAN-13 with 5 digit supplement which is a bar code of 978055337062153495. It would be transmitted in ISBN format as 0553370626. 055337062 are the first nine digits of the ISBN format, and 6 is the newly calculated Mod-11 check digit.

To enable the transmission of the ISBN format, scan **Terminator Character** and **D**. Scanning **C**, the default setting, disables conversion to ISBN format back to regular EAN-13 format.

MSI and Plessey

Disable MSI	0
Enable MSI with 1 Mod 10 check digit	1
Enable MSI with 2 Mod 10 check digits	2
Enable MSI with 1 Mod 11 and 1 Mod 10 check digit	3
Transmit No MSI Check Digits	4
Transmit 1 MSI Check digit	5
Transmit 2 MSI Check digits	6
Enable Plessey (mutually exclusive with MSI)	7
Enable LabelCode5	8
Enable LabelCode4	9

For more information about MSI code, see Appendix I.

Codabar

Enable Codabar	0
Disable Codabar	1
Enable CLSI Codabar	2
Disable CLSI Codabar	3
Enable Start/Stop Character Transmission	4
Disable Start/Stop Character Transmission	5

For information about Codabar, see Appendix E.

CLSI format is a form of Codabar often used by libraries.

Enabling Start/Stop character transmission means that the WDR Reader will transmit start/stop characters to your computer along with data. If you're varying start/stop characters with different label types, you'll want to enable transmission.

Code 128

Disable Code 128	0
Enable Code 128	1
Disable UCC/EAN-128	2
Enable UCC/EAN-128	3
Enable Storage Tek Tape Label Code	C
Disable StorageTek Tape Label Code	D
Bar Code IDs transmitted	E
Bar Code IDs not transmitted	F

Bar Code ID characters can be transmitted as a leading character to identify the bar code symbology type scanned. **To enable a Bar Code ID character** (a for Codabar, b-Code 39, c-UPC-A, d-EAN-13, e-I2of5, f-2of5, g-128, j-MSI, i-93, n-UPC-E0, o-UPC-E1, p-EAN-8, x-Plessey, y-LabelCode4, z-LabelCode5, s-STK) to be transmitted at the beginning of each bar code read, wand **E**.

To disable bar code ID characters, wand **E**.

For information about Code 128, see Appendix F.

RSS-14

Disable RSS-14	0
Enable Standard 14 digits	1
Enable 14 plus Identifiers	2
Enable 14 plus UCC 128 Emulation	3

By default, standard RSS-14 is disabled, scan 1 to enable. Options 3 and 4 enable the alternate RSS-14 formats. For more information on RSS-14, see the AIM website at http://www.aimglobal.org/standards/symbinfo/rss_overview.asp

2 of 5 Code

Enable Interleaved 2 of 5	0
Disable Interleaved 2 of 5	1
Enable Interleaved 2 of 5 Check Digit	2
Disable Interleaved 2 of 5 Check Digit	3
Enable Check Digit Transmission	4
Disable Check Digit Transmission	5
Enable Standard 2 of 5	6
Disable Standard 2 of 5	7

For information about Interleaved and Standard 2 of 5, see Appendix G.

Enabling the Check Digit requires the data's units position to match the calculation for the check digit explained in Appendix G. *If you've enabled the check digit, enabling Check Digit transmission* causes the reader to transmit it to your computer along with the bar code data.

2 of 5 Data Length

2 of 5 Code is so susceptible to interpreting partial scans as valid reads that the Radio/Freedom Reader uses fixed-length data as a safeguard. **To choose a data length**, scan it as a two-digit number using the Barpad Table. For example, to select 8-digit data length, you would scan a 0 and then an 8. **Because Interleaved 2 of 5 is required to be an even number of digits in length**, you must use an even number. If you're unsure of your bar code length, **temporarily** set the length to **00**, read a bar code, and count its digits and then set it to the actual length. **DO NOT PERMANENTLY SET THE 2 of 5 LENGTH TO 00 or you will get misreads!**

Code 93

Enable Code 93	0
Disable Code 93	1
Enable Full ASCII Code 93	2
Disable Full ASCII Code 93	3

For more information on Code 93 see Appendix J.

Inter-character delays

None	0
Short	1
Short Medium	2
Medium	3
Long	4

The WDR Reader can transmit bar code data with five different inter-character delay rates (this is independent of baud rate). Most computers work perfectly with no delay, but with the wide variety of systems out there we have to provide some delay rates. Older minicomputers in particular expect delays with “keyed” data.

Baud rate

300	0
600	1
1200	2
2400	3
4800	4
9600	5
19,200	6

Sets the baud rate according to the baud rate your terminal, or the baud rate you want to use with your serial port.

Data bits

7 Bits	0
8 Bits	1

Set the data bits (“word length”) to the same setting your terminal is using, or you want to use with your serial port.

Parity

None	0
Even	1
Odd	2

Set parity to the same setting your terminal is using, or the one you want to use with your serial port. None is usually used in conjunction with 8 data bits; Even or Odd with seven data bits.

Stop bits

1 Bit	0
2 Bits	1

Set the stop bits to the same setting your terminal is using, or you want to use with your serial port.

Protocol

None	0
XON/XOFF	1
ACK/NAK	2
Polled – No ACK/NAK	3
Polled with ACK/NAK	4
Host Response Enabled	5
Host Response Disabled	6

"None"

means that the WDR will transmit bar code data to the computer without waiting for a request or response. Unless you're connecting multiple readers to one serial port, you'll probably want to select "None" protocol.

"XON/XOFF"

XON/XOFF protocol should be used only with a single WDR Reader connected to a dedicated serial port. Don't use it if your Reader is connected between a computer and terminal. XON/XOFF lets your computer disable and enable bar code reading, allowing the computer to perform time-consuming tasks with no data loss. The computer sends the WDR an **XOFF** (ctrl-S) when busy, and an **XON** (ctrl-Q) when ready to receive bar code data again. On receipt of the **XON**, the WDR's LED changes to red, and bar code reading is disabled. When the computer sends the **XOFF**, the reader resumes normal operation and its LED returns to green.

"ACK/NAK"

protocol can be used to confirm data accuracy, (especially with long RS-232 cables). With **ACK/NAK** selected, the reader appends a checksum to the end of the data, and waits for an **ACK** (control-F) or **NAK** (control-U) from the host before reading any more codes or turning its LED back to green. The WDR calculates a checksum by 1) XOR-ing the data to a single byte, 2) expanding the resulting byte to 2 bytes. i.e., suppose we are transmitting the data **123** followed by a Carriage Return. The WDR XOR's the three bytes (the "123") to Hex **30**; the high order nibble is transmitted as **33**, and the low order nibble is transmitted as **30**. The computer must calculate the checksums exactly the same way as the

WDR and then compare its calculated checksums with the ones received from the WDR. If they match, the computer transmits an **ACK** back to the WDR; if they don't match, the computer transmits back a **NAK** to the WDR. When the reader receives an **ACK** or **NAK**, or times out, its LED returns to green. The reader does not beep for an **ACK**, but produces two long beeps for a **NAK** or time-out. Set time-out duration with **Host Response Delay**, described on page 23.

"Polled - No ACK/NAK"

causes the WDR to wait for the host to poll it (send that particular Reader's ID character, and a **CR**) before transmitting bar code data. This applies only to multiple readers connected to one serial port and is not the preferred method, which is **"Polled with ACK/NAK"** described below and has an example program on page 36. See page 35 for detailed explanations of polling.

"Polled with ACK/NAK"

After being polled with its ID, the WDR transmits the bar code data with a checksum appended. The host then calculates the checksum characters (see **"ACK/NAK"** on the previous page for the details), and compares it with the two checksums received. If they're the same, the host sends that reader's ID and an **ACK**. If different, the host sends the ID and a **NAK**. When the reader receives its ID and the **ACK** or **NAK**, or if it times out, its LED returns to green. The reader doesn't beep for an **ACK**, but produces two long beeps for a **NAK** or time-out. Set time-out duration with **Host Response Delay**, described on page 23. For a sample program to perform Polling with ACK/NAK, see page 37. See page 35 for detailed explanations of polling.

"Host Response Enabled"

gives the host computer the power to cause the Reader to emit two different types of beeps, and its LED to flash orange, by sending a control character out the serial port to the reader. Especially if the reader is some distance from the computer so the person reading bar codes doesn't see the screen, you may want to use this feature to signify that a code was or was not accepted and that it was read in the proper sequence.

Sending a control-G (**BEL** - ASCII 7) to the reader produces one quick beep and orange flash.

Sending a control-R (**DC2** - ASCII 12 hex or 18 decimal) to the reader produces two long beeps and a long orange flash.

To use "Host Response Enabled" mode with Polled or Polled with ACK/NAK Protocol, the host computer needs to precede the **BEL** or **DC2** with the ID character of the WDR Reader they are intended for. **"Host Response Disabled"** disables this ability.

Set ID Character

(For Polling protocol only.) Before a WDR using polling protocol can transmit data to your computer, the computer must poll the reader with that particular reader's ID character. ID characters can be any lower case letter, the punctuation characters {, |, }, ~, or DEL.

Scan a unique character on the "FULL ASCII MENU" to set each WDR to a unique ID. For instance, to give your first WDR an ID of "a", you'd scan the lower case letter a. See pages 35 and 36 for more information about polling.

Reset

Don't scan **Reset** unless you're sure you want to restore the WDR Reader to its default settings (as described on page 9), erasing all changes you've made, because that's exactly what **Reset** will do.

Preamble

A "Preamble" is a user-specified data string transmitted at the beginning of each bar code. For example, if you specify the preamble @@ and read data of **123456**, "@@**123456**" would be transmitted to your computer. With the 2-Way LZ2x2-RF Laser, the Preamble applies to the scanner, not the base station because there may be multiple scanners per base.

The default is no preamble. To select a preamble, wand up to 15 characters from the "FULL ASCII MENU" on the back of the *Reader Setup Menu*, and then wand **SET** when you're done. To return to the no preamble setting, wand **Clear** here instead of wandering **SET** or any characters from the FULL ASCII MENU.

You can **trim 1-15 leading characters** from bar code codes by wand a ~ (tilde -- ASCII 126) followed by a single digit, 1 through F, as part of the Preamble. (Bar codes that are shorter than the amount-to-trim are transmitted with no trimming.) Consider the examples in the following table to understand how trimming works:

Bar Code Data	Preamble	Data Transmitted
123	XYZ	XYZ123
12345678	~3XYZ	XYZ45678
12345678	~9	12345678
12345	~A	~A12345
123456	~5	6

You can also trim selectively by bar code type. For example, you can trim 2 characters from Code 39 and a different amount from other bar code outputs. This is done by using the bar code ID character in conjunction with the tilde. A preamble of ~b2~c1 says trim 2 characters from the front of Code 39 output and trim 1 character from the front of UPC-A. Refer to the Code 128 parameter on page 16 for a list of the ID characters associated with each bar code type.

A final use of the Preamble/Postamble is to enter a minimum/maximum length check for bar code data read. Use the Preamble or Postamble by entering |nnmm where "|" is ASCII 124, "nn" is the two digit minimum to be read and "mm" is the two digit maximum to be read.

Postamble

"Postamble" refers to a user-specified data string transmitted at the end of each bar code. For instance, if you specify the postamble @@ and read data of **123456**, "**123456@@**" would be transmitted to your computer.

The default is no postamble. To select a postamble, wand up to 15 characters from the "FULL ASCII MENU" on the back of the *Reader Setup Menu*, and then wand **SET** when you're done. To return to the no postamble setting, wand **CLEAR** here instead of wand **SET** or any characters from the FULL ASCII MENU.

You can **trim 1-15 trailing characters** from bar code codes by wand a ~ (tilde -- ASCII 126) followed by a single hex digit, **1** through **F**. (Bar codes which are shorter than the amount-to-trim are transmitted without trimming.) Consider the examples in the following table to understand the options of the Postamble:

Bar Code Data	<u>Postamble</u>	<u>Data Transmitted</u>
123	XYZ	123XYZ
12345678	~3XYZ	12345XYZ
12345678	~9	12345678
12345	~A	12345~A
123456	~5	1

Bar codes that are shorter than the sum of the Postamble trimming and Preamble trimming will be transmitted without trimming. Selective trimming and min/max bar code data is also supported through Postamble specifications, (See **Preamble** above for complete details).

Host Response Delay

(For ACK/NAK protocol in the R22)

If you want the WDR Reader to time-out rather than wait forever for a response from the host computer, scan a "seconds" value as a two-digit number. For example, to set a 5-second time-out you would scan 0 and then 5. Scanning 00 sets an infinite delay (which is the default).

Characters

This setup option allows you to output ASCII characters different from the ones scanned.

For example: Suppose you want the WDR Reader to output a hex 92 character every time you scan a 1 (hex 31); you want to remap hex 31 to hex 92, (If you're using 8 data bits, output of 80-F8 codes is possible.)

- 1) Scan the **Start Setup** Bar Code
- 2) Scan the **Characters** Bar Code on the Setup Sheet.
- 3) Scan **3 1** and **9 2** to output hex 92 when reading a "1".
- 4) Scan up to 7 other pairs of character reassignments.
- 5) Scan **Set** when complete.
- 6) Scan **End Setup** to exit setup mode.

Hex values for each character code are shown on the *Full ASCII Menu*, (the back of *WDR Setup Menu*). The equivalent decimal values are also shown for each character.

You can also eliminate characters by reassigning hex codes to FF. For example, to strip all \$ (dollar sign) characters from transmission, you would follow the above instructions and wand **2 4 F F** in step 3.

Keyboard country (applies to PC-TERM only)

This option configures the WDR Reader for your choice of 15 keyboard country settings, such as USA (the default), UK, French, German, etc. See Appendix L for information on PC-TERM, (rarely used since 1995).

Terminator characters

Enter (carriage return)	0
None	1
HT	2
CR/LF	3

Depending on your application, you may wish your WDR Reader to transmit bar code data to your computer with an **Enter** (carriage return), a **Tab** at the end, or with no extra terminating character at all. If you need a terminator character other than **CR** or **HT** or **CR/LF**, you can get it by specifying **None** here and then selecting your desired terminator character(s) specified in the **Postamble** (See Page 22).

MagStripe

None	0
Track 1	1
Track 2	2
Track 3	3
Two Track Scanner, Both Output Only	4

Two Track Scanner, Both or 2 Output Only	5
Two Track Scanner, 1 or 3 Output Only	6
Track 1&2 Scanner, 2 Output Only	7
Caps Lock Off	E
Caps Lock On	F

Use None (the default) if you don't have a MagStripe scanner. For single-track scanners, use 1, 2 or 3 to match its track. To read both tracks 1 and 2 only, use 4; use 5 to read either Tracks 1&2 or Track 2 only cards. See page 28 for more information on the MagStripe scanner.

Data Format

RS-232 ASCII	0
RS-232 "PC-Terminal Mode"	1

RS-232 ASCII is used for almost all serial ports and terminals.

"**PC-Terminal Mode**" is rarely used since 1995. (See *Appendix L* for more information on PC-Terminal options.)

Test the Reader with your computer

If running Windows, install and run the WDRTEST program distributed with the WDR reader, (or download it from our Website www.barcodehq.com). If you ordered PortKey, use PortKey instead of the WDRTEST program. Now go to *Notepad* in your Windows programs, and scan data according to below:

- Bar code wands or laser scanners: Following the scanning instructions on page 10 and 11, scan the test label on the next page.
- Bar Code and MagStripe Slot Scanners:



For a bar-code slot scanner, take the Reader Setup Menu "A" card and turn it so the A bar code is pointing down and facing the lighted side of the scanner. Make a continuous swipe motion through the slot in either direction.

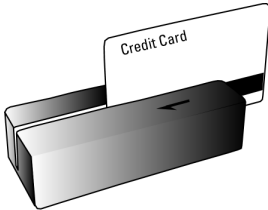

For a MagStripe slot scanner, take a magnetic-strip card of the type you will be using, and turn it upside down so the stripe is pointing down. Move the card through the scanner in a continuous swipe in the direction of the arrow.

You should hear a beep, and the reader's LED should briefly flash red.

If you are using the *Windows Notepad* program, or if you've connected it between your computer and terminal, you should see

TEST LABEL

displayed on your screen. (Or an **A**, if you're using a bar code slot scanner, or your magnetic-strip-card data, if you're using a MagStripe slot scanner.)

You can also use a modem or communications program, or your own software, to see if your computer is receiving "**TEST LABEL**".

If you can't read the "TEST LABEL", or if your computer isn't receiving the data, work through the troubleshooting section beginning on page 39.

Wand scanner

A high-quality, stainless steel, visible-light, USA made wand scanner is available with the WDR. The F52/3 medium/high wand scanner is capable of reading all printed media bar codes including dot matrix, laser, thermal, thermal transfer, inkjet, etc. This wand can read high density bar codes, (i.e. high density up to 15 characters per inch). The wand scanner is very durable and has a removable, replaceable wand tip. It has a white sapphire glass tip which protrudes and therefore doesn't accumulate dirt and paper dust.

Using the Bar Code Slot Scanner

Depending on your application, you may want to use a slot scanner as your bar code input device instead of or in addition to a wand. Worth Data makes a bar code slot scanner that plugs into either of the WDR Reader's **Scanner or Magstripe ports**, and is designed for reading bar codes printed on badges or ID cards. It can also be used for reading bar codes on file folders, envelopes and any other thin, flat surfaces with bar codes printed along an edge.

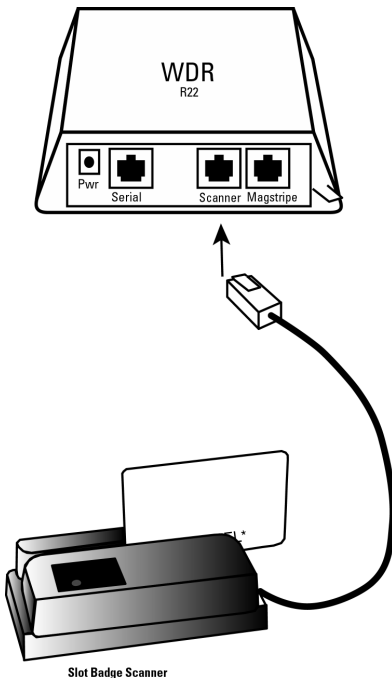

There are two types of bar code slot scanners:

- The standard bar code slot scanner is a medium-resolution scanner using visible-red light. It also reads high-density bar codes.
- Optionally, you can specify a medium-resolution infrared-light scanner.

To read a card or other object with the bar code slot scanner, orient the card so that its bar code faces the lighted side of the scanner. Now make a continuous swipe motion through the slot.

For optimum use with the slot scanner, bar codes should be printed so that the center of the bar code is .45" from the bottom edge of the card.

The Slot Scanner can be permanently mounted to a desk or wall by removing the 4 screws on the bottom of the unit and replacing them with screws that are long enough to go through the surface and into the slot scanner.

Using the MagStripe Slot Scanner

The MagStripe Slot Scanner options (track 1, track 2, track 3, or track 1 and 2 or 2 and 3) enable the WDR Reader to read credit and other magnetic-strip cards without disconnecting or disabling the bar code wand. These stationary scanners read tracks 1 and 2, or 2 and 3, of magnetically-encoded cards meeting the standards defined by ANSI x 4.13, ANSI x 4.16 1983, ISO 3554 and ISO 2894.

There are two requirements for using a MagStripe Slot Scanner:

- The MagStripe Slot Scanner must be plugged into your WDR Reader's **MagStripe** port.

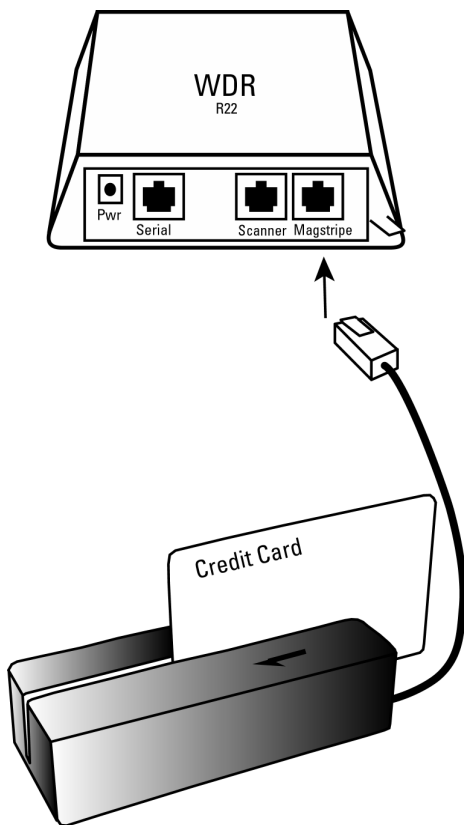

The MagStripe scanner can be permanently mounted to a surface using the threaded holes on the bottom. To use the MagStripe Slot Scanner, turn the card upside-down so the stripe can be read. Move the card through the scanner in a continuous swipe in the direction of the arrow. When the reader makes a good read, it will beep once and transmit the data to the computer.

Plug the MagStripe Slot Scanner into the WDR Reader's **MagStripe** port as shown below, and use the Reader Setup Menu to configure your reader for your MagStripe scanner track setting, as described on page 24.

Laser and CCD Scanners

Worth Data laser and CCD scanners plug directly into WDR Reader **SCANNER** port. Laser scanners add these abilities to the WDR Reader:

- Fast reading of difficult bar codes.
- Reading bar codes from a distance
- Operator reading moving objects, such as on an assembly line.
- No-hands operation: Laser scanners can be mounted on a stand to turn on automatically when an operator passes an object under them.
- Reading through thick (up to five inches) glass or plastic laminates.
- Reading curved surfaces, such as plastic bags of items.

Warning: These laser scanners (not CCD scanners) use low-power, visible-light laser diodes. Although momentary exposure to the beam is not known to be harmful, the user should avoid staring directly into the beam, or shining the beam into people's eyes.

Laser scanners are triggered, 5-volt, visible-light, moving-beam scanners that attempt to read 36 times per second. CCD scanners attempt to read 44 times per second. If the code misreads ten times, you don't even know it.

Worth Data LZx00 series

These scanners are manufactured by Worth Data using the Symbol 1200 Scan Engine family. They are very lightweight, easy to handle, rugged, and aggressive scanners on all types of codes and densities. The scan element has a lifetime warranty. They are tested with repeated drops at 10 ft. to concrete. The cord has a 1,000,000 bends lifetime.

The LZ400 reads at twice the distance most other lasers read -- 1 to 21" with a 4.2 cpi Code 39 bar code or about 15 inches on a 100% UPC Code. The LZ400-D scanner can be configured with an aiming dot. The decode is very quick. The lower cost LZ300 reads from 1-14" on the same Code 39 code as above and about 10" from a UPC code. It has a less powerful laser but it is just as reliable and decodes very quickly.

These laser scanners use a low-power, visible laser diode. Although momentary exposure to a CDRH II laser scanner is not known to be harmful, avoid staring directly into the beam or shining the beam into other people's eyes. The required

safety label to advise the user of the laser cautions appears on these lasers as shown:

The LZ300 and LZ400, are covered by one or more of the following U.S. patents:

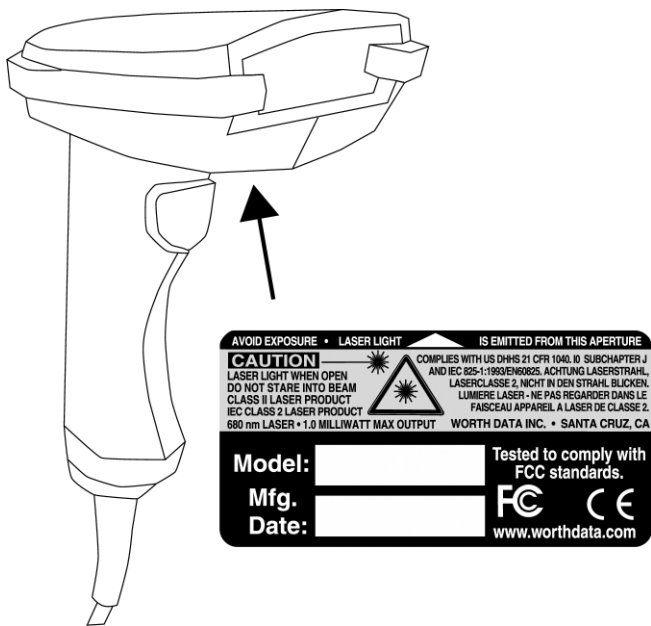

Patent#:4,360,798; 4,387,297; 4,460,120; 4,496,831; 4,593,186; 4,603,262; 4,607,156; 4,652,750; 4,673,805; 4,736,095; 4,816,660; 4,845,350; 4,896,026; 4,897,532; 4,923,281; 4,933,538; 4,992,717; 5,015,833; 5,017,765; 5,021,641; 5,029,183; 5,047,617; 5,103,461; 5,113,445; 5,140,144; 5,142,550; 5,149,950; 5,157,687; 5,168,148; 5,168,149; 5,180,904; 5,229,591; 5,230,088; 5,235,167; 5,243,655; 5,247,162; 5,250,791; 5,250,792; 5,262,627; 5,280,163; 5,280,164; 5,280,498; 5,304,786; 5,304,788; 5,321,246; 5,377,361; 5,367,151; 5,373,148; 5,378,882; 5,396,053; 5,396,055; 5,399,846; 5,404,081; 5,410,139; 5,410,140; 5,142,198; 5,418,812; 5,420,411; 5,436,440; 5,444,231; 5,449,891; 5,449,893; 5,468,949; 5,479,000; 5,479,002; 5,479,441; 5,504,322; 5,528,621; 5,532,469; 5,543,610; 5,545,889; 5,552,592; 5,578,810; 5,589,680; 5,612,531

A stand is available for all of the Worth Data lasers and CCDs that allows hands free reading of bar codes. Just before placing the scanner in the stand, scan the bar code on the stand to set the laser into an automatic reading mode. When an operator presents a bar code under the laser the narrow searching beam is turned on fully to read the bar code presented. The stand is available in a mountable goose neck (S11) or in a freestanding version (S21).

Below is a drawing showing how the Lx00 Laser Scanner mounts into the stand with the weighted base.

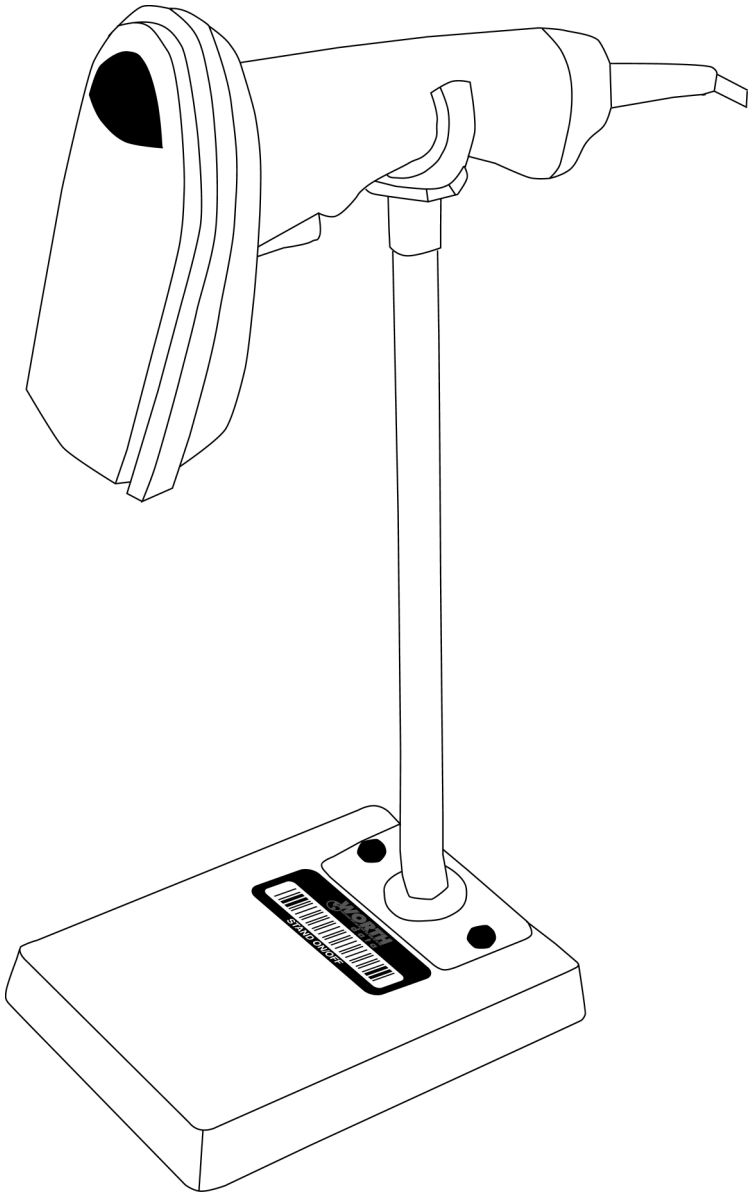

Four laser scanner options:

“Double-scan checking”: To minimize the possibility of misreads with very poorly printed bar codes or when reading through windshields, you have the option of forcing the WDR to keep reading until it gets two results that are exactly the same. This "double scan checking" takes a little longer, but it will eliminate misreads. To activate double scan checking:

Scan **Start Setup**

Scan **Code 39**

Scan **E** to enable double scan checking.

Scan **End Setup**

To *disable* double scan checking, scan **F** instead of **E**.

4-second beam: Another option with problem reading conditions is to increase the length of the time the scanner attempts to read, from the default 2-second beam to a 4-second beam. To select the 4-second beam:

Scan **Start Setup**

Scan **2 of 5**

Scan **F** to select the 4-second beam

Scan **End Setup**

To return to the default 2-second beam, scan **E** instead of **F**.

Continuous Scanning Option for the CCD scanner: Sometimes it is desirable to read sheets or lists of bar codes without having to activate the trigger before each read. To activate the CCD continuous scanning:

Scan **Start Setup**

Scan **Data Format**

Scan **B** to select continuous scanning

Scan **End Setup**

To disable continuous scanning, repeat the above, substituting **C** for **D**.

"Aiming Dot for LZ400-D Scanner": The LZ400-D scanner can be set to project an aiming dot for a specified number of seconds before the beam spreads and attempts to read the bar code. This can be useful for trying to read a bar code in direct sunlight or when trying to read one bar code among many on a label or page. To turn on an aiming dot, scan the following:

Scan **Start Setup**

Scan **Beep Tone**

Scan **A** for 1 sec, **B** for 2 secs, **C** for 3 secs, **D=4**, **E=5**, or **F=6** secs

Scan **End Setup**

To disable "Aiming Dot", repeat the above, but scan **9**, the default setting.

Accumulate Mode

Accumulate Mode is an option (which can be enabled or disabled using the *Reader Setup Menu's* Code 39 section) allowing the reader to accumulate multiple bar codes in its buffer, then transmit them to the computer as if they had been a single bar code. This is useful for entering quantities and other variable data. A small laminated barpad card is provided with each reader ordered to aid in entering variable quantities.

It works with Code 39 only, and can't be used with a check digit. When the reader reads a bar code with a *leading space*, it beeps and buffers the data without transmission. It continues to read and buffer bar codes (up to 40 characters) until it reads a bar code *without* a leading space. Then the entire buffer (including that last code) is transmitted as one long bar code. A bar code of a double minus (--) sign clears the buffer. Scanning a backspace code (\$H) backspaces in Full ASCII mode. A handy code for Enter (as seen on the "Barpad" below) is a Start/Stop only. (No data.)

This numeric "Barpad" illustrates Accumulate Mode. Scan **5, 3, 8**, and **Enter**. The reader transmits a single message of **538**.

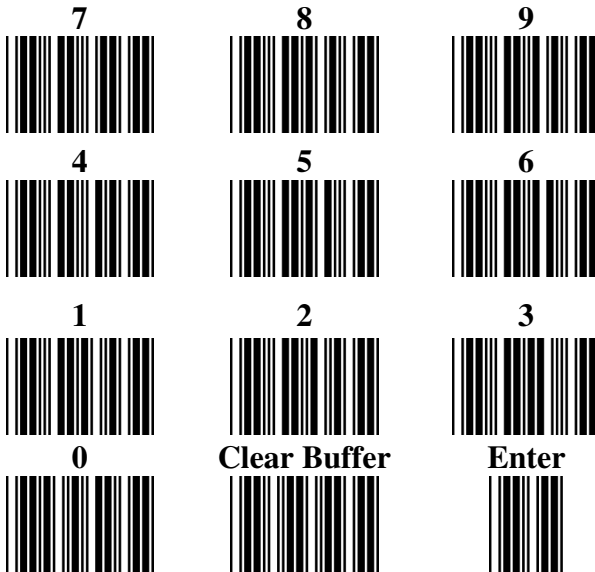

Function/Control Key Support

Function/Control Key Support with PortKey

Using PortKey, the can emulate the special keys on the PC keyboard. PortKey expects the "extended key code" convention outlined in the BASIC manuals and most compiler manuals. For example, to transmit a F1 key from a WDR using PortKey to the PC's keyboard, a *null* (ASCII 0) followed by a *semicolon* (ASCII 59) would be required. You can use Full ASCII Code 39 or Code 128 to transmit the required sequences. The following is a list of the most common keys, the required codes and the equivalent Code 39 characters:

PC Key	ASCII Character	Code 39
Ctrl @	0,3	%U\$C
Ctrl A	2 (SOH)	\$A
Ctrl B	3 (STX)	\$B
Ctrl C	4 (ETX)	\$C
Ctrl D	5 (EOT)	\$D
Ctrl E – Ctrl Y	6 (ENQ) – 25 (EM)	\$E - \$Y
Ctrl Z	26 (SUB)	\$Z
Ctrl [27 (ESC)	%A
Ctrl \	28 (FS)	%B
Ctrl]	29 (GS)	%C
Ctrl ^	30 (RS)	%D
Ctrl _	31 (US)	%E
F1	0,59 (Null ;))	%U%F
F2	0,60 (Null<)	%U%G
F3	0,61 (Null=)	%U%H
F4 – F9	0,62 (Null>) – 0,67 (NullC)	%U%i-%UC
F10	0,68 (Null D)	%UD (or %U /D)
Home	0,71 (Null G)	%UG (or %U /G)
Up Arrow	0,72 (Null H)	%UH
Pg Up	0,73 (Null I)	%UI
Left Arrow	0,75 (Null K)	%UK
Right Arrow	0,77 (Null M)	%UM
End key	0,79 (Null O)	%UO
Down Arrow	0,80 (Null P)	%UP
Pg Dn	0,81 (Null Q)	%UQ
Ins	0,82 (Null R)	%UR
Del	0,83 (Null S)	%US
Shift F1	0,84 (Null T)	%UT
Shift F2 – Shift F9	0,85 (Null U) – 0,92 (Null \)	%UU – %U%L
Shift F10	0,93 (Null)	%U%M
Ctrl F1	0,94 (Null ^)	%U%N
Ctrl F2 – Ctrl F9	0,95 (Null _) – 0,102 (Null f)	%U%O – %U+F
Ctrl F10	0,103 (Null g)	%U +G
Alt F1	0,104 (Null h)	%U +H
Alt F2 – Alt F9	0,105 (Null i) – 0,112 (Null p)	%U+i - %U+p
Alt F10	0,113 (Null q)	%U +q

Polling

Polling is supported by PortKey for Windows. It allows cycling of files so that you can process the data of a just closed file while continuing to collect data in the next generation file. PortKey is only \$40 when purchased with a reader.

To connect and configure your WDR readers for polling, do the following:

1. **Hook up your readers.** Daisy-chain your readers to your computer as shown on page 7. Connect the scanners and power supplies, and plug the power supplies into your outlets, as shown on page 3. You should hear three beeps as you plug each reader into the wall.
2. **Configure your readers.** Follow the configuration instructions starting on page 10 to set each reader's communications and bar code configuration. Set **Protocol** to **Polled - No ACK/NAK** or **Polled with ACK/NAK**, depending on whether or not you want to use the ACK/NAK protocol. (If you are using the PortKey program for polling, you must set the **Terminator Character** to **CR**.)
3. **Assign each reader a unique ID.** Take the first reader's scanner and read the **Start Setup** and **Set ID Character** codes. Then turn the setup menu over to the FULL ASCII MENU and read the code for the ID you want to give that reader. ID characters can be any lower case letter, or one of the punctuation characters { , | , } , ~ , or **DEL**. For instance, to give the reader an ID of a, read the bar code below the lower case letter **a**. Then turn the sheet back over and read **End Setup**. Repeat this process for each reader, assigning a different ID character to each one.

How polling works:

When a reader using Polled protocol reads a bar code, that reader beeps once, its LED turns from green to red, and it stores the bar code data in its buffer. For the purposes of this explanation, let's suppose that the person using a reader with the ID character a just read the bar code **123456**, and the person using reader b is on a lunch break.

PortKey for Windows or your custom software, running on the host computer, polls the WDR readers one by one, by transmitting each of their ID characters (followed by carriage returns -- **CR**), one by one, over the serial port.

As each reader's ID character is transmitted, the reader with that ID character assigned responds with:

- If the reader has no data in its buffer to transmit, it sends back its ID character and terminator character* only, and briefly flashes its LED.

- If the reader has data to transmit, its LED returns to green, and it sends back its ID character, the bar code data, and its terminator character*.

So when the computer transmits an **a** (and **CR**), reader **a** responds with a123456 (and its terminator character*), and its LED returns to green. When the computer transmits a **b** (and **CR**), reader **b** responds with a **b** and its terminator character* only, and its LED flashes off and on.

* The default "*Terminator Character*" is **CR/LF**, (but you must change it to **CR** for the PortKey polling to work correctly).

Your software reads the data from the serial port, and processes it according to your needs. If you care which reader read what data, your software can tell by the ID character at the start of the data; otherwise the ID can be discarded. The computer and readers poll and respond very quickly; people using the readers are not conscious of any delays due to multiple readers.

Time-outs: If you poll a reader when it is in the middle of reading a bar code, the reader may not see that it has been polled. To prevent your computer from waiting forever for a response from a reader that missed "hearing its name called", your software needs to be able to time out and resume polling. See the BASIC program below for an example of time-out use.

This example BASIC program polls and differentiates between data from three readers that have been assigned ID characters of a, b, and c. (We don't recommend you use this program. Instead we recommend you use the program on the next page which include ACK/NAK; this program is supplied for understanding only.)

```

10 OPEN "COM1:9600,N,8,1,DS,CS" AS #1
20 ID$(1) = "a":ID$(2) = "b":ID$(3) = "c"      'Reader ID's
30 FOR POLL = 1 TO 3                          'Three reader loop
40 BC$=""                                     'Clear data before poll
50 PRINT #1,ID$(POLL) CHR$(13);              'Poll a reader
60 FOR TIMEOUT = 1 TO 100                     'Timeout loop
70 IF NOT(EOF(1)) THEN 100                    'If response, go read it
80 NEXT TIMEOUT
90 GOTO 150                                    'Timed out
100 CHARACTER$ = INPUT$(1,1)                  'Read one char at a time
110 IF CHARACTER$ = CHR$(13) THEN 130         'Is it terminator char?
120 BC$ = BC$ + CHARACTER$:GOTO 100          'Append chars to data
130 IF LEN(BC$) = 1 THEN 150                  'See if data is ID only
140 PRINT "Reader ";MID$(BC$,1,1);" read: ";MID$(BC$,2,LEN(BC$)-1)
150 NEXT POLL                                  'Poll next reader
160 GOTO 30                                    'Back to first reader

```

To use this program, or BASIC programs using INPUT statements to read the serial port, use the Reader Setup Menu to set all your readers to use **CR** terminator characters rather than **CR/LF**.

If you are transmitting over a long distance, you should use **Polled with ACK/NAK** protocol to decrease the chance of noise distorting the data. The following is a program to use ACK/NAK too:

```

10 DIM ID$(3)
20 NAK$=CHR$(21):ACK$=CHR$(6):TRUE=-1:FALSE=0
30 OPEN "COM1:9600,N,8,1,RS,DS,CD" AS #1
40 ID$(1)="a":ID$(2)="b":ID$(3)="c"           'ID for 3 units
50 FOR IL=1 TO 3                               'loop on 3 units
60 B$=""                                       'clear input buffer
70 PRINT #1,ID$(IL);CHR$(13);                 'poll one unit
80 J=0                                         'reset timeout count
90 IF NOT(EOF(1)) THEN 120                     'unit respond yet ? if yes,-> 50
100 J=J+1                                     'increment timeout count
110 IF J=50 THEN 180 ELSE GOTO 90              'if timeout then poll next,else wait
120 A$=INPUT$(LOC(1),#1)                       'read com1 buffer
130 B$=B$+A$                                  'add to input buffer
140 IF RIGHT$(A$,1)<>CHR$(13) THEN 80           'if <CR> rcvd then output else rcv
150 IF LEN(B$)=2 THEN 180                      'if msg = id + <CR> then poll next
160 GOSUB 220                                  'verify checksum & send ack/nak
170 IF RESPONSE THEN PRINT LEFT$(B$,LEN(B$)-3) 'display msg
180 FOR I=1 TO 100:I=I:NEXT                    'delay a while then poll next
190 NEXT
200 GOTO 50
210 REM the delay counts in statements 330 & 380 can be changed
220 RESPONSE=TRUE:COMPUTEDSUM=0
230 TRSUMLOW=ASC(MID$(B$,LEN(B$)-1,1))
240 TRSUMHI=ASC(MID$(B$,LEN(B$)-2,1))
250 FOR I=1 TO LEN(B$)-3
260 R$=MID$(B$,I,1)
270 COMPUTEDSUM=COMPUTEDSUM XOR ASC(R$)
280 NEXT I
290 CKSUMLOW=COMPUTEDSUM MOD 16 + 48
300 CKSUMHI=COMPUTEDSUM\16 + 48
310 IF CKSUMHI=TRSUMHI AND CKSUMLOW=TRSUMLOW THEN 370
320 PRINT #1,ID$(IL);
330 FOR I=1 TO 20:I=I:NEXT
340 PRINT #1,NAK$;
350 PRINT "NAK HAPPENED !!"
360 RESPONSE=FALSE:RETURN
370 PRINT #1,ID$(IL);
380 FOR I=1 TO 20:I=I:NEXT
390 PRINT #1,ACK$;
400 RETURN

```

To form the two checksum characters for ACK/NAK, all bytes (except the terminator Character) are Exclusive OR'ed together. Instead of the resulting checksum character being transmitted, the high order nibble and low order nibble are each added to Hex 30 (ASCII 48) and then two bytes are transmitted. For

example, suppose you are transmitting 123, followed by a CR(Hex 0D) to the host. The TriCoder ORs the three bytes to Hex 30 (ASCII 48); the high order nibble is transmitted as 33 and the low order nibble is transmitted as Hex 30. (The previous BASIC program illustrates this calculation and conversion.)

The transmission format for polled WDR Readers is:

[ID] [Preamble] [DATA] [Postamble] [Checksum Chs] [Terminator]

Troubleshooting

If you're unsure about the settings of the reader (for instance, if another person may have changed some of them), return it to its default settings by scanning the **Start Setup** and **Reset** codes. Then reconfigure it for your system and application using the instructions beginning on page 9 as a guide.

The reader does not beep three times when you plug it into the wall, and the LED does not light:

1. Plug something else into that outlet to make sure it's good, or try another outlet that has been working with something else.
2. If the outlet is good, either the power adapter or the WDR Reader is not working properly -- call Worth Data.

The reader doesn't beep when you try to read your bar codes:

1. Make sure the power adapter is plugged into both the WDR Reader and a functioning electric outlet.
2. Try reading a known good bar code -- the test label on page 6, following the steps for proper scanning technique on pages 11 and 12.
3. Try scanning at different speeds -- a common error is scanning too slowly.
4. Read the instructions beginning on page 9 on configuring the WDR Reader for different bar code types and formats, and make sure you properly enabled the bar code types you're trying to read.
5. If you configured the reader to use **Polling** protocol, it needs to be polled by your computer before it will read more than one bar code.
6. If you configured it for **Polling with ACK/NAK**, you also need to send an **ACK** or **NAK** after each read (unless you've specified a finite time-out) as well as polling the reader, before it will read more than one bar code.
7. If the read failure is on Interleaved 2 of 5 codes, make sure the data length is the same that you selected on the Setup Menu.
8. Be sure you don't have the check digit enabled for Code 39, Code 128, or Interleaved 2 of 5 if you're trying to read data without check digits.

The reader transmits extra characters at the beginning or end of your bar code data:

1. Clear the ID character, Preamble and Postamble.

2. Make sure you haven't enabled transmission of any start/stop characters, checksums or leading digits you don't want transmitted, and that Terminator Character is set to **CR/LF**, **CR**, **HT** or none as you desire. For UPC-E, select **Compressed** if you don't want it padded with zeros.

Poor read rate:

1. Try reading the test label on page 26 (following the scanning instructions on pages 10 and 11) as an example of a known good bar code. Examine your bar codes to make sure they have dark bars, clearly defined bars and white spaces, and a "quiet zone" of at least 1/4 inch to the left and right. If the bars are gray, or so dark that they "bleed" into the white spaces, the person or organization printing them will need to adjust the printer or get a new ribbon or toner cartridge for it.
2. If you're using an infrared bar code wand, be sure the bar codes you're trying to read were printed with infrared-quality ink.
3. If using a wand scanner, try scanning at different speeds -- a common error is scanning too slowly. If using a CCD or laser scanner, try scanning at different distances from the bar code.
4. If using a wand scanner, remove the wand tip from the wand with a coin inserted into the grooves at the tip of the barrel. Hold it up to a light or a window and look through it to make sure it's clean. Clean any dirt or debris from the inside of the tip with a Q-tip. (Do not touch the red plastic inside the wand).
5. If using a laser or CCD scanner, clean the window if it is dirty.

The reader beeps on reads, but nothing appears on your screen or (if you're using your own software to read the serial port) is read by your software:

1. Recheck the installation instructions beginning on page 3 to make sure all cables are properly connected.
2. If you're trying to read Code 39 bar codes with leading spaces (such as the Barpad on page 33) and have enabled Code 39 Accumulate Mode, those bar codes will not be transmitted to your computer until you read a bar code without a leading space. Try reading the Test Label on page 26 as an example of a known good label.
3. If you're the WDR Test Program distributed with the WDR or PortKey, verify that the data bits, parity and stop bits in the program settings match the Reader's settings with the Reader Setup Menu.
4. Try a different serial port on the same computer or try a different computer. Check for serial driver conflicts running on that same serial port.

5. If you're using your own software to read the serial port, verify that the problem is not in your software by running a modem or communications program set to that serial port, and seeing if it gets any data on the screen when you read a bar code.
6. Try setting the reader to **Half Duplex**. If data appears on the screen then, you need to switch pins 2 and 3 in the DB-25 end of the cable.
7. Use a "null modem" connector to test switching pins 2 and 3 on one or more serial cables, or get a technician with a breakout box to modify your cable(s).

The reader transmits data to your screen or serial port, but some characters or missing:

1. Make sure you've set the reader to the same baud rate, parity, data bits and stop bits as your serial port.
2. If Code 39 bar codes are transmitting in the wrong (upper and lower transposed) case, set **Caps Lock Off** on the Setup Menu.
3. Make sure you've set **Data Format** properly for your system –RS-232 ASCII is 99.99% probable unless you have ordered RS-422 as an extra charge feature.
4. If you're using your own software to read the serial port, consider that some software occasionally cannot keep up with high baud rates

The reader transmits funny characters instead of the correct data:

Your baud rate or parity is not set on the reader to match the software's settings.

WDR Reader Cables and Pinouts

There are several WDR Reader cable selection options for use with different types of computer systems and serial ports:

- F34: A single null-modem cable with a female DB-25 connector, for direct attachment to a 25-pin serial port.
- F36: A single straight-through cable with a female DB-9 connector, for direct attachment to a 9-pin serial port.
- F45-1: Serial Y Cable for use between a terminal and host, or for daisy-chaining RS232 readers together.

This and the next two pages list the pin-outs for the above cable selections.

F34 Cable Selection

These are the pinouts for Cable Selection F34 (a single null-modem cable with a female DB-25 connector), when attached to the Serial port of the WDR.

<u>Signal</u>	Female <u>DB-25</u>	Host <u>Port</u>
Frame Ground	1	1
Transmit data	3	2
Receive data	2	3
Signal ground	7	4

F36 Cable Selection

These are the pinouts for Cable Selection F36 (1 straight-through cable with a female DB-9 connector), when attached to the WDR's Serial port.

<u>Signal</u>	Female <u>DB-9</u>	Host <u>Port</u>
Frame Ground	(shell)	1
Transmit data	2	2
Receive data	3	3
Signal ground	5	4

Request To Send is tied high on both ports so the WDR Reader will always be able to transmit with systems using RTS/CTS protocol.

Clear To Send, Data Set Ready and **Data Terminal Ready** are passed straight through between the host and terminal ports -- if your system uses any of these lines for handshaking, the handshaking will continue as before, with no interference from the reader. If you need DTR to be high, you will need to change a jumper setting. See appendix B.

Opening the WDR Case

Use the illustrations below as a guide for opening the WDR case, if you need to change or verify any jumper settings, or adjust the beeper volume.

Turn your Reader upside-down, and unscrew its single Phillips screw. If you don't completely remove the screw, you can use it as a lever to pull up on the cover; otherwise, insert a fingernail, credit card edge or small screwdriver blade into the gap between the base and side of the case, and gently use it as a lever to lift up the edge of the base. Then grasp the edge of the base and open it outward like a door.

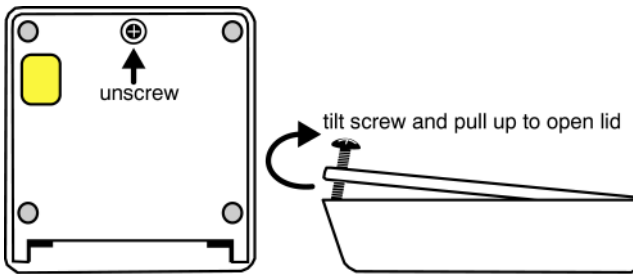

This exposes the WDR circuit board, as shown below. Don't bother taking it out of the case -- you can check or change jumper settings just fine as it is. When you've finished examining or changing jumper settings, put the WDR Reader's case back together by reversing the steps pictured on this page

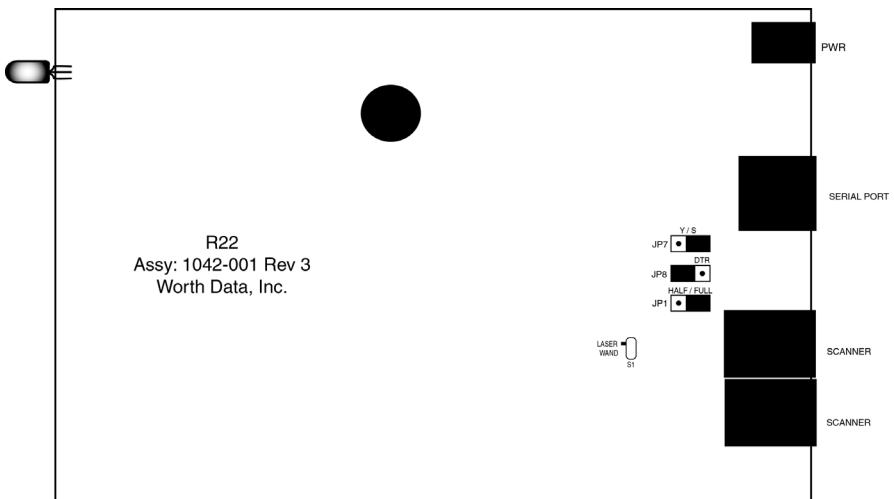

Jumper & Switch Settings

Open the WDR Reader's case using the instructions in Appendix A.

S1, the Input Device switch:

"S1" is the switch on the WDR board near the scanner input ports. The **W** and **L** settings are a little misleading, because you can actually use the laser scanner with either setting. Read the descriptions below to determine which setting to use:

W

If you have an older wand scanner, you may have to use the **W** jumper setting to get the wand to scan. New wands work on this setting too. A laser scanner will work on this setting, but the decode light will not turn on at a good read. Using a laser scanner with the **W** setting causes the laser scanner's decode light to be on all the time. This means that your laser scanner will not give a visual indication (flashing decode light) of a successfully read bar code, but since most people just listen for the WDR Reader's beep anyway instead of staring at the laser scanner, this is unlikely to affect anyone.

L

This is the default setting for the WDR 22 and should be used for all scanners shipped after 7/2001. This will cause the laser scanner's decode light to flash as a bar code is successfully read. The jumper must be set to **L** for the laser stand mode to operate successfully.

JP1, the Half / Full Duplex jumper:

For standard RS232 communication on a dedicated PC serial port, the WDR should be set to Full Duplex. This is the default setting.

If you are using the WDR on a terminal-host configuration with the F45-1 Serial Y Cable, then you **may** need to set JP1 to Half Duplex. See the troubleshooting section for more information.

JP7, the Y / S jumper:

This jumper determines standard serial port configuration (PC, dedicated serial port) or Host / Terminal configuration. The default is **S**, for standard serial. If you have ordered the F45-1 Serial Y Cable for use between a terminal and host, you will need to move this jumper to **Y**.

JP8, the DTS jumper:

This jumper determines whether to force DTR high or not. By default, DTR is NOT high. To force DTR high, switch the jumper to DTR.

Specifications for Code 39

Code 39 (or Code 3 of 9) is the de facto standard of non-retail American industry. It is widely used in the automotive industry (AIAG specifications) as well as in government and military applications (LOGMARS specifications). Code 39 is flexible, features a large character set, variable data length and density, and bi-directional readability. Code 39 is extremely accurate; substitution errors are almost nonexistent. Its character set consists of numbers **0** through **9**, upper case **A-Z**, and characters *Space*, *\$*, *%*, */* + and *-*.

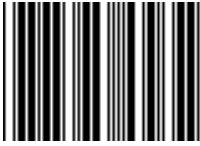

C39

The name "Code 39" comes from both the fact that its character set originally contained 39 characters (it now has 43) and from its structure. Each character is formed of three wide and six narrow elements, made up of five bars and four spaces. Code 39's density can vary from a low of .75 characters per inch (cpi) to a high of 9.4 cpi. There should be a ¼" "*quiet zone*" (white space) to the left and right of the bar code.

Code 39 uses an asterisk (*) as a start and stop character. This character must precede and follow the data in the bar code. The WDR gives you the option of transmitting or not transmitting these characters when the bar code is read.

Exact specifications for Code 39 and other bar code symbologies can be obtained from ANSI at the address below:

American National Standards Institute
Customer Service
11 West 42nd St.
New York, NY 10036
<http://web.ansi.org>

document ANSI/AIM BC1-1995

Code 39 has several advanced features and functions that are discussed further in this appendix.

Code 39 Advanced Features and Functions

Mod 43 Check Character

Standard Code 39 can be printed with a "Mod 43 Check Character". This Mod 43 check character *cannot* be used with **Full ASCII Code 39**. The check character is derived by assigning a value to each character in the data to be bar coded from the table as follows:

Char	Value	Char	value	Char	value	Char	value
0	0	B	11	M	22	X	33
1	1	C	12	N	23	Y	34
2	2	D	13	O	24	Z	35
3	3	E	14	P	25	-	36
4	4	F	15	Q	26	.	37
5	5	G	16	R	27	space	38
6	6	H	17	S	28	\$	39
7	7	I	18	T	29	/	40
8	8	J	19	U	30	+	41
9	9	K	20	V	31	%	42
A	10	L	21	W	32		

Table A-1. Mod 43 Check character calculation for Code 39

Here is an example to illustrate how the check character is calculated for bar code data of **123XYZ**:

1. Take the sum of the values assigned to each character:

$$\begin{array}{cccccc} \mathbf{1} & + & \mathbf{2} & + & \mathbf{3} & + & \mathbf{33} & + & \mathbf{34} & + & \mathbf{35} & = & \mathbf{108} \\ I & & 2 & & 3 & & X & & Y & & Z & & \end{array}$$

2. Divide the sum by **43**: (thus the name modulus 43)

$$\mathbf{108/43 = 2 \text{ with a Remainder of } 22}$$

3. Find the character corresponding with the remainder.

M (value 22) is the CHECK CHARACTER

The data becomes **123XYZM**, with **M** added as the Mod-43 check character.

Full ASCII Extension to Code 39

"Full-ASCII Code 39" expands the Code 39 character set to include all 128 ASCII characters. Symbols 0-9, A-Z and punctuation characters . and - are identical to their Code 39 representations. Lower-case letters, additional punctuation characters and control characters are represented by sequences of *two Code 39* characters.

This table depicts the Full ASCII character set as a function of Code 39 characters:

ASCII	Code 39	ASCII	Code 39	ASCII	Code 39	ASCII	Code 39
NUL	%U	SP	Space	@	%V	'	%W
SOH	\$A	!	/A	A	A	A	+A
STX	\$B	"	/B	B	B	B	+B
ETX	\$C	#	/C	C	C	C	+C
EOT	\$D	\$	/D	D	D	D	+D
ENQ	\$E	%	/E	E	E	E	+E
ACK	\$F	&	/F	F	F	F	+F
BEL	\$G	'	/G	G	G	G	+G
BS	\$H	(/H	H	H	H	+H
HT	\$I)	/I	I	I	I	+I
LF	\$J	*	/J	J	J	J	+J
VT	\$K	+	/K	K	K	K	+K
FF	\$L	,	/L	L	L	L	+L
CR*	\$M	-	-	M	M	M	+M
SO	\$N	.	.	N	N	N	+N
SI	\$O	/	/O	O	O	O	+O
DLE	\$P	0	0	P	P	P	+P
DC1	\$Q	1	1	Q	Q	Q	+Q
DC2	\$R	2	2	R	R	R	+R
DC3	\$S	3	3	S	S	S	+S
DC4	\$T	4	4	T	T	T	+T
NAK	\$U	5	5	U	U	U	+U
SYN	\$V	6	6	V	V	V	+V
ETB	\$W	7	7	W	W	W	+W
CAN	\$X	8	8	X	X	X	+X
EM	\$Y	9	9	Y	Y	Y	+Y
SUB	\$Z	:	/Z	Z	Z	Z	+Z
ESC	%A	;	%F	[%K	}	%P
FS	%B	<	%G	\	%L		%Q
GS	%C	=	%H]	%M	{	%R
RS	%D	>	%I	^	%N	~	%S
US	%E	?	%J	_	%O	DEL	%T, %X

Table A-2. Full ASCII Table

Codabar Specifications

Codabar is widely used in libraries, blood banks, the cotton industry and transportation industries. Its character set consists of numbers **0** through **9**, and punctuation characters **+**, **.**, **-**, **/**, **:** and **\$**. Symbols **a**, **b**, **c**, **d**, **t**, **n**, ***** and **e** are used as start and stop characters. Characters are constructed of four bars and three spaces.



a12345b

Codabar is a numeric-only code, but different combinations of start and stop characters can be used to identify different types of labels. Codabar's variable data length and extremely low error rate make for a versatile bar code.

Codabar start/stop transmission

The Codabar section on the WDR Setup Menu lets you determine whether Codabar start/stop characters are transmitted or not. If you are varying start/stop characters with different types of labels, you'll want to "**Enable Stop/Start character Transmission**". Start/stop character transmission can also be helpful if you want your program to differentiate between data coming from the WDR and data coming from the keyboard. If neither of these situations apply, you'll probably want to disable it.

Code 128 Specifications

Code 128 is a very powerful bar code, combining an extensive character set and variable length with compactness and error checking. The character set contains all 128 ASCII characters with each character made up of three bars and three spaces. Each element (bar or space) varies from one to four units in width, totaling 11 units of width per character. Code 128 contains two levels of error checking:

- Each character is checked for internal parity, **and**
- The last character is a checksum.

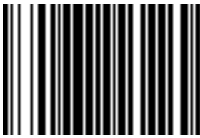

12345

Code 128 has three subsets, A, B and C. Subset A contains alphanumeric characters and unprintable control characters, subset B contains alphanumeric characters plus printable control characters and subset C contains only numeric characters and uses a 2-character encoding scheme to create a more compact bar code. Code 128 uses an internal Mod 103 check character that is not displayed by the bar code

reader. Code 128 bar codes can be made up of only one subset or may be a combination of several.

The Code 39 features of **Accumulate Mode**, **Caps Lock ON** and **Caps lock OFF** also apply to Code 128.

UCC-128/ EAN-128

UCC-128/EAN-128 Code is a subset of Code 128 adopted by the UCC and EAN council's for use as a shipping label symbology. UCC/EAN-128 bar codes always start with a Function Code 1 character. In addition, all variable length fields are terminated by a Function Code 1 character unless they are the last field in the bar code.

The WDR outputs the following for the special function codes and start sequences:

]C1 Start C/Function Code 1

^] (GS) Function Code 1 as a variable string terminator

If **UCC/EAN-128** is enabled and the WDR Reader sees a 128 bar code starting with an *Function Code 1*, the WDR interprets the code as an UCC/EAN-128 bar code. UCC/EAN-128 bar codes can be of any length and have any characters for data. A subset of the UCC/EAN-128 bar code is the **Serial Shipping Container**

Code, a 20 numeric digit code beginning with a Start C and Function Code 1 and terminating with a MOD 10 Check Digit. This is to comply with the **Uniform Code Council's Serial Shipping Container Code** specification.

The Mod 10 Check digit is calculated the same as the *Interleaved 2 of 5* example in *Appendix D*. It is the MOD 10 check digit that distinguishes the *Serial Shipping Container Code* from other UCC /EAN 128 bar codes.

Scanning the appropriate bar codes on the WDR Setup Menu enables **UCC/EAN-128**. If UCC/EAN-128 is enabled, all formats of 128 will be reads; but, if there is a Function Code 1 leading the data, the code will be treated as a UCC/EAN-128 bar code. If UCC/EAN-128 is enabled, and a 20 digit 128 bar code that starts with Start C/Function Code 1 is detected, it will not be readable unless the low order digit passes the Mod 10 check digit calculation.



UCC 128 Shipping Container Code

The UCC 128 specification is used extensively by the retail industry. If you have a requirement for a **UCC 128 Serial Shipping Container** bar code, be sure to follow the specification as closely as possible as many vendors will impose fines for non-conformance. For more information on UCC 128, contact the GS1 US at:

GS1 US (Formerly Uniform Code Council)
7887 Washington Village Drive, Suite 300
Dayton, OH 45459
937-435-3870

Many of the specifications are available online at:

<http://www.gs1us.org>

Interleaved 2 of 5 Code

Interleaved 2 of 5 Code is a numeric-only, even-number-of-digits bar code. It is widely used in warehouse and industrial applications. A combination of five elements, two wide and three narrow represent each character. Odd-number position digits are encoded in the bars, even-number positions in the spaces.



Interleaved 2 of 5 Code is so susceptible to partial scans being interpreted as valid reads that we recommend at least one of the following safeguards:

- **Use one length of I 2 of 5 code.** Using one length of data allows you to tell the WDR to look for one length of I 2 of 5 code only. By default, the WDR is set to look for a 6 digit I 2 of 5 code but you can set the length to something different using the WDR Setup Menu. Setting the length to **00** digits allows variable length bar codes scanning. If you must use the **00** setting, we recommend that you then use the “*Minimum/Maximum*” data length field when creating a program in the WDR to check each field for the proper length.
- **Use a check digit.** Worth Data’s **LabelRIGHT** printing program automatically calculates and prints a check digit upon request using the method below:

Interleaved 2 of 5 Mod 10 check digit calculation

1. Assume that the bar code data is **1987**.
2. Starting with the least significant digit (in this case, a 7), label the digits alternatively even and odd.

7 - even
8 - odd
9 - even
1 - odd

3. Take the sum of the odd digits:

$$8 + 1 = 9$$

4. Multiply the sum of the even digits by 3:

$$(7 + 9) \times 3 = 48$$

5. Add the results of steps 3 and 4:

$$9 + 48 = 57$$

6. Subtract the result of step 5 from the next highest multiple of 10:

$$60 - 57 = 3$$

7. The checksum becomes the low-order digit:

19873

8. Because the data now has an odd length, a leading zero is added, for the final result of

019873

UPC Specifications



UPC symbols are found on almost all grocery products and many other retail items. The UPC code most people are familiar with (UPC-A) is a fixed-length (12 digits) numeric only code, with the first digit controlled by UPC coding assignments and the last digit a checksum. UPC-E and UPC-E1 are variations of the standard UPC-A code. Each

digit is constructed of two bars and two spaces. UPC has very precise standards of code size, structure, and numbers to be used.



EAN is an international superset of UPC. EAN-13 has 13 digits, with the first two digits representing a country code. The final digit is, as with UPC, a check digit. EAN-8 is a shorter version on the EAN-13 code containing seven data digits and ending again with a checksum.

The exact UPC/EAN symbol specifications are available from:

**GS1 US (Formerly Uniform Code Council)
7887 Washington Village Drive, Suite 300
Dayton, OH 45459
937-435-3870**

Specifications are also available via the Internet at:

<http://www.gs1us.org>

Keep the following guidelines in mind when printing UPC bar codes:

- If you plan to use a "supermarket-type" in-counter scanner to read the codes, specify a bar code height of at least .9" for an optimal first read rate.
- Make it an early practice to observe the numbering conventions of the GS1 US. Do not label unmarked merchandise with a bar code whose numbers may conflict with those already assigned. If products with these numbers are not in your store now, they are likely to be in the future, causing conflicts in your inventory system.

- The leading Number System Character, (the first number of the 11 digits to be entered) should conform to these UPC assignments:
 - 0,6,7,8** Regular UPC 12 digit codes with numbers assigned by the GS1 US. (*Do not use 0 as the leading number for in-store marking*).
 - 2** Store-marked random weight items of meat and produce.
 - 3** Reserved for National Drug Code and Health Related Items.
 - 4** Use this leading digit for in-store marking of non-food items.
 - 5** Reserved for coupons.

UPC 2 and 5-character supplemental codes



The UPC standards include the addition of a 2 or 5-character supplemental code used with magazines and paperback books plus the extended coupon codes using UCC/EAN-128. To read the supplements, you must first enable them using the WDR Setup Menu.

ISBN Specifications

ISBN (International Standard Book Numbering) bar codes are essentially EAN-13 with a 5 digit supplement, where the first 3 digits are the Bookland country codes of **978** for books and **977** for periodicals. Although the bar code contains 18 characters, the ISBN format uses only 9 of them, along with a newly calculated Mod-11 check digit. For example, a bar code containing the numbers 978055337062153495 would transmit as 0553370626 in the ISBN format. The WDR has the option of transmitting in the ISBN format.



ISBN specifications are available from:

**American National Standards Institute
Customer Service
11 West 42nd St.
New York, NY 10036
<http://web.ansi.org>**

document ISO 2108:1992

The UPC/EAN checksum character

The last character in a UPC-A, UPC-E, UPC-E1, EAN-13 or EAN-8 bar code is the checksum. For reference, these are the methods of calculation:

Checksum calculation for UPC-A, EAN-13 and EAN-8

Use Worth Data's USA phone number (it's not a real UPC-A code) as sample data:

18314589938

Assign even and odd positions, starting at the right and moving left:

8	3	9	9	8	5	4	1	3	8	1
odd	even	odd	even	odd	even	odd	even	odd	even	odd

1. Starting with the leading digit, 8, take the sum of all the characters in the odd positions.

$$8 + 9 + 8 + 4 + 3 + 1 = 33$$

2. Multiply the result of step 1 by 3.

$$33 \times 3 = 99$$

3. Now take the sum of all the even-position characters.

$$3 + 9 + 5 + 1 + 8 = 26$$

4. Add the result in Step 2 to the result in Step 3.

$$99 + 26 = 125$$

5. Subtract the result from the next higher multiple of 10.

$$\text{Next higher multiple of 10 over 125} = 130$$

$$130 - 125 = 5$$

5 is the *Modulo-10* check character. The data to be printed becomes:

183145899385.

This same formula is used for EAN-13 (using the 1-12 digits) and EAN-8 (using the 1-7 digits).

UPC-E Checksum Calculation

Use the sample data of 123456 to demonstrate the UPC-E checksum calculation:

1. The 6 digit UPC-E code is converted to a 10-digit code, using an expansion scheme based on the sixth digit:

If the code ends in:	UPC-E Data	Insertion Digits	Insertion Position	10 digit code
0	abcde 0	0000	3	Ab 0000 cde
1	abcde 1	1000	3	Ab 1000 cde
2	abcde 2	2000	3	Ab 2000 cde
3	abcde 3	0000	4	Abc 0000 de
4	abcde 4	0000	5	Abcd 0000 e
5	abcde 5	0000	6	Abcde 0000 5
6	abcde 6	0000	6	Abcde 0000 6
7	abcde 7	0000	6	Abcde 0000 7
8	abcde 8	0000	6	Abcde 0000 8
9	abcde 9	0000	6	Abcde 0000 9

Because the sample UPC-E code ends in a **6**, the insertion digits **0000** are inserted at the **sixth digit** (insertion position 6):

1234500006

2. Add the Number System Character of 0 to the sample data:

01234500006

3. Use the UPC-A check digit calculation described in the previous section to produce a check digit as if it were a UPC-A code. The check digit for the sample data is:

5

4. The complete 8 digit code consists of the *Number System Character*, the *original 6 digit code* and the *check digit*:

01234565

MSI/Plessey Specifications

Plessey is a variable length numeric only bar code. **MSI Bar Code** is a variable length, numeric-only code with an automatically appended Modulus 10 check digit. MSI is sometimes called *Modified Plessey Code*. If the user specifies an additional check digit, the MSI code can be 14 digits long, otherwise it has a maximum length of 13 characters. This is how the MSI check digit(s) are calculated:

The MSI **Mod 10** check digit is calculated as follows:

The example bar code data is:

82345

1. Form a number from the odd positions, starting in the units position.

835

2. Multiply the new number by 2

(835) x 2 = 1670

3. Add the digits of product

1 + 6 + 7 + 0 = 14

4. Add the even digits of the original number to the result in 3

2 + 4 + 14 = 20

5. Subtract the result from the next highest multiple of 10

20 - 20 = 0

6. New Check Digit

0

7. Data with check digit is:

823450

The MSI **Mod 11** check digit is calculated as follows:

The example bar code data is:

943457842

1. Assign a checking factor to each number, starting with the units position of the number (in this example, the **2**) up to the highest order position (the **9**). Use checking factors of:

2,3,4,5,6,7,2,3,4,5,6,7...

2. Multiply the checking factor with its assigned number and add the products:

$$4 + 12 + 32 + 35 + 30 + 28 + 6 + 12 + 36 = 195$$

3. Divide the sum by 11

$$195/11 = 17 \text{ remainder } 8$$

4. Subtract remainder from 11

$$11 - 8 = 3$$

5. New Check Digit

3





(If the remainder is 10, no check digit is added.)

6. Data with check digit is:

943457823

Code 93 Specifications

Code 93 is variable length, continuous, bi-directional, compact code. Code 93 is an alphanumeric bar code which consists of *43 data characters (0-9, A-Z, \$/+ %.- and Space)*, *4 control characters*, and a *unique start/stop character*. The entire set of 128 ASCII characters is represented in Code 93 using combinations of *control characters and data characters*.

The control characters are , , , and . Full ASCII 93 is created by pairing these control characters with normal data characters. It is almost identical to the pairings for Code 39; Code 39 uses \$M to produce a Carriage Return (ASCII 13) character -- Code 93 uses M to produce the Carriage Return.

Code 93's two built-in check digits greatly minimize the possibility of reader substitution errors. These check digits are never transmitted by the bar code reader. Code 93's Start and Stop characters are also never transmitted.

If you have not decided which bar code type to use for your application and are considering using Code 93, while we agree that Code 93 is an excellent code, we believe that Code 128 is generally preferable because:

1. Code 93 **does not** have the numeric compression capability that 128 does, and
2. Code 93 requires pairings to make all Full ASCII characters while 128 does not.

PC Terminal Mode

Since the mid-90's, PC Terminal mode is a rarity, so it is unlikely that any new system you are installing would use PC-Terminal Mode.

"PC-Terminal Mode" is only used when these three conditions are met:

- You are running a network or multi-user operating system (Concurrent DOS, PC-MOS, NTNX, ATNX, NX-386, etc.) on a PC or AT-type computer.
- Your system is using "PC-Terminal" type terminals, like the Kimtron KT series, the Wyse 60, the Link or the Televideo PC Terminal, and they are in PC-Terminal rather than ASCII mode.
- The WDR reader is connected between one of those terminals and a serial port, rather than to a dedicated serial port.

For advanced PC-Terminal mode users: emulating special keys.

Programmers and other advanced PC-Terminal mode users can also embed keyboard hex scan codes in the preamble, for emulation of key presses specific to their terminals, such as the left shift key or F12 key. This is done by specifying the make and break hex scan codes for one or more keys enclosed in "left" and "right" apostrophes (` and `). Make and break codes are hardware-specific -- see the keyboard section of your terminal's manual or tech ref for descriptions of its make and break codes. Break codes follow one of two conventions depending on which "keycode set" a keyboard uses. Keycode set 1 (usually on XT-style systems) uses a two-digit break code formed by adding hex 80 to the make code.. Keycode set 2 (usually on AT-style systems) uses two two-digit break codes: the first is F0 and the second is identical to the make code. For example, let's say you want to emulate the left shift key.

First, using the Full ASCII Menu, you'd scan a left apostrophe, to identify subsequent characters as keyboard scan codes. Next, the two-digit hex make code -- let's say it's 12. First you'd scan a 1 and then a 2. Next, the break code. Let's say your system uses keycode 2 break codes of F0 followed by the make code. Finally, a right apostrophe to mark the end of the scan codes.

If you are using **"PC-Terminal" mode**, your reader can emulate the full keyboard reading bar codes. In PC-Terminal mode, when the reader reads a Code 128 or Full-ASCII Code 39 bar code containing one of the control characters shown in the table below, it will transmit the corresponding function key to your computer. For example, if you scan a bar code of SOH (ctrl-A), the WDR Reader will transmit the PC's F1 key sequence.

FA or C128	Code 39	Function or Control Key	FA or C128	Code 39	Function or Control Key
SOH	\$A	F1	DC4	\$T	Right Arrow
STX	\$B	F2	NAK	\$U	Down Arrow
ETX	\$C	F3	SYN	\$V	Up Arrow
EOT	\$D	F4	VT	\$K	PgUp
ENQ	\$E	F5	FF	\$L	PgDn
ACK	\$F	F6	ETB	\$W	Home
BEL	\$G	F7	CAN	\$X	End
SO	\$N	F8	EM	\$Y	Shift ON
SI	\$O	F9	SUB	\$Z	Shift OFF
DLE	\$P	F1	FS	%B	Ctrl ON
DC1	\$Q	Del	GS	%C	Ctrl OFF
DC2	\$R	Insert	RS	%D	Alt ON
DC3	\$S	Left Arrow	US	%E	Alt OFF

The **SHIFT**, **CTRL**, and **ALT** keys must use two sequences of bar codes:

1. The code generated when the key is pressed down -- the ON key.
2. The code generated when the key is released -- the OFF key.

For example, to properly encode a bar code sequence for **Ctrl-C**, you would create a bar code of **Ctrl ON**, **C**, and **Ctrl OFF**.

Keyboard country

"Keyboard country" only applies to readers using PC-Terminal mode. This option configures the WDR Reader for your choice of 15 keyboard country settings, such as USA (the default), UK, French, German, etc.

Scan the keyboard country bar code and then the two-digit code for your keyboard country (listed on the Reader Setup Menu), such as **14** for UK.

WDR Setup Menu

To change a setting using the WDR Setup Menu:

- Scan **START SETUP** to enter setup mode
- Scan the **parameter** you want to change (i.e. Code 3 of 9)
- Choose the **setting** you want to change and scan the corresponding letter or number from the Barpad Table (0-9, A-F)
- When all changes have been made, scan **END SETUP**
- For Preamble and Postamble settings, use the **FULL ASCII MENU**
- * indicates default settings

Start Setup



End Setup



Code 3 of 9



- *0) **Enable Code 39**
 - 1) Disable Code 39
- *2) **Enable Full ASCII Code 39**
 - 3) Disable Full ASCII Code 39
- *4) **Enable Accumulate Mode**
 - 5) Disable Accumulate Mode
 - 6) Transmit Start/Stop characters
- *7) **Don't transmit Start/Stop characters**
 - 8) Enable Mod 43 Check Character
- *9) **Disable Mod 43 Check Character**
 - A) Transmit Mod 43 Check Character
- *B) **Don't transmit Mod 43 Check Character**
 - C) Caps Lock ON
 - *D) **Caps Lock OFF**

UPC/EAN



- *0) **Enable UPC/EAN**
 - 1) Disable UPC/EAN
 - 2) Enable Supplements
- *3) **Disable Supplements**
- *4) **Transmit UPC-A NSC**
 - 5) Don't transmit UPC-A NSC
- *6) **Transmit UPC-A Check Digit**
 - 7) Don't transmit UPC-A Check Digit
 - 8) Transmit UPC-E NSC & EAN-8 Flag Ch
- *9) **Don't transmit UPC-E NSC & EAN-8 Flag Ch**
 - A) Transmit UPC-E & EAN-8 Check digit
 - *B) **Don't transmit UPC-E & EAN-8 Check digit**
- *C) **UPC-E Compressed transmission**
 - D) UPC-E Expanded transmission
- *E) **EAN-8 observes 9 & A above**
 - F) EAN-8 is forced to transmit 8 digits always

2 of 5 Code



- 0) Enable I 2 of 5
- *1) **Disable I 2 of 5**
 - 2) Enable check digit
- *3) **Disable check digit**
 - 4) Transmit check digit
- *5) **Don't transmit check digit**
 - 6) Enable 2 of 5
- *7) **Disable 2 of 5**

2 of 5 Length



Scan 2 digit length (default is 06)

RSS-14



- 0) **Disable RSS-14**
 - 2) 14 + Identifiers
 - 1) Standard 14 digits
 - 3) 14 + UCC-128 Emulation

Start Setup



End Setup



Code 93



- 0) Enable Code 93
- * 1) **Disable Code 93**
- 2) Enable Full ASCII Code 93
- * 3) **Disable Full ASCII Code 93**

Code 128



- * 0) **Disable 128**
- 1) Enable 128
- * 2) **Disable UCC/EAN-128**
- 3) Enable UCC/EAN-128

Codabar



- 0) Enable Codabar
- * 1) **Disable Codabar**
- 2) Enable CLSI Codabar
- * 3) **Disable CLSI Codabar**
- * 4) **Suppress start/stop characters**
- 5) Enable start/stop characters

MSI/Plessey



- * 0) **Disable MSI**
- 1) Enable MSI 1 Mod 10 check digit
- 2) Enable MSI 2 Mod 10 check digits
- 3) Enable MSI Mod 11/10 check digits
- * 4) **Transmit no check digit**
- 5) Transmit 1 check digit
- 6) Transmit 2 check digits
- 7) Enable Plessey
- 8) Enable Labelcode 5
- 9) Enable Labelcode 4

Data Format



- * 0) **RS-232 ASCII**
- 1) PC Term Mode
- 2) RS-422

Intercharacter Delay



- * 0) **None**
- 1) Short
- 2) Short Medium
- 3) Medium
- 4) Long

Terminator Character



- * 0) **CR**
- 1) Tab
- 2) None
- 3) CR/LF

Beep Tone



- 0) Lowest
- 1) Low
- * 2) **Medium**
- 3) High
- 4) Highest
- 5) No Beep Tone

Characters



Scan up to 8 sets of hex characters to reassign and delete characters in the bar code output. Scan SET when completed.

Keyboard Country (PC TERM MODE ONLY)



- | | | |
|-----------------|----------------|---------------|
| *00 USA | 05 Danish | 10 Portuguese |
| 01 French | 06 Dutch | 11 Spanish |
| 02 German | 07 Italian | 12 Swedish |
| 03 Belgian | 08 Latin Amer. | 13 Swiss |
| 04 Fr. Canadian | 09 Norwegian | 14 U.K. |

Start Setup

End Setup



Protocol



- * 0) None
- 1) XON / XOFF
- 2) ACK / NAK
- 3) Polled - No ACK / NAK
- 4) Polled with ACK / NAK
- 5) Host Response Enabled
- * 6) Host Response Ignored

Set ID Character



Scan Characters (ASCII 96-127) for polled address from Full ASCII Menu

Baud Rate



- 0) 300
- 1) 600
- 2) 1200
- 3) 2400
- 4) 4800
- * 5) 9600
- 6) 19,200
- 7) 38,400

Host Response Delay



(Applies to ACK/NAK only)
Scan 2 digits for # of seconds or, scan 00 for infinite delay.

Data Bits



- 0) 7 bits
- * 1) 8 bits

Stop Bits



- * 0) 1 Bit
- 1) 2 Bits

Parity



- * 1) None
- 2) Even
- 3) Odd

Magstripe



- * 0) None
- 1 Track 1
- 2 Track 2
- 3 Track 3
- 4 Tracks 1 & 2, 2 & 3

Start Setup



End Setup



Preamble



Scan up to 15 characters from the **Full ASCII Menu**. Scan **SET** when completed.

Postamble



Scan up to 15 characters from the **Full ASCII Menu**. Scan **SET** when completed.

SET



CLEAR



Clears Preamble & Postamble and resets current individual parameter back to default settings.

STAND MODE



















Scan this bar code to put the WDR into and out of "hands-free" stand mode when using the S21 and S11 Stands.

RESET



Warning: Scanning this bar code after scanning **START SETUP** will reset the reader back to all of the default parameter settings.

BARPAD TABLE

0 	8 
1 	9 
2 	A 
3 	B 
4 	C 
5 	D 
6 	E 
7 	F 

Full ASCII Menu

NUL 000 00	SOH(f1) 001 01	STX(f2) 002 02	ETX(f3) 003 03
EOT(f4) 004 04	ENQ(f5) 005 05	ACK(f6) 006 06	BEL(f7) 007 07
BS 008 08	TAB 009 09	LF 010 0A	VT(Pg Up) 011 0B
FF(Pg Dn) 012 0C	CR 013 0D	SO(f8) 014 0E	SI(f9) 015 0F
DLE(f10) 016 10	DC1(Del) 017 11	DC2(Ins) 018 12	DC3(←) 019 13
DC4(→) 020 14	NAK(↓) 021 15	SYN(↑) 022 16	ETB(Home) 023 17
CAN(End) 024 18	EM(Shift On) 025 19	SUB(Shift Off) 026 1A	Esc 027 1B
FS(Ctrl On) 028 1C	GS(Ctrl Off) 029 1D	RS(Alt On) 030 1E	US(Alt Off) 031 1F
SP 032 20	! 033 21	" 034 22	# 035 23
\$ 036 24	% 037 25	& 038 26	' 039 27
(040 28) 041 29	* 042 2A	+ 043 2B
, 044 2C	- 045 2D	. 046 2E	/ 047 2F
0 048 30	1 049 31	2 050 32	3 051 33
4 052 34	5 053 35	6 054 36	7 055 37



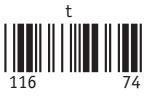

Index

2

- 2 of 5 Code
 - about 51
 - data length 16, 37, 51
 - default settings 8, 16

A

- Accumulate Mode 12, 31, 38
- ACK/NAK protocol
 - checksum calculation 19
 - configuring 18
 - host response delay 21
 - with polling 19, 33, 37
- Advanced Features/Functions 46
- AIAG 45
- Aiming Dot for LZ400-D Scanner 30
- Alt key support 61
- ANSI information for Code 39 45
- Automatic scanning stands 28
- Automobile ID reading 30

B

- Bar code slot scanner
 - how to use 9
- Bar codes
 - Accumulate mode 31
 - character substitution 21
 - continuous scanning 30
 - default settings 8
 - ID character prefix 15
 - Preambles and Postambles 20
 - reading through windshields 30
 - terminator characters 22
 - trimming characters 20
- Baud rate 17, 38
- Beeping
 - and Accumulate Mode 31
 - and ACK/NAK protocol 19
 - and scanning 24
 - changing pitch 11
 - during configuration 10
 - if your reader doesn't beep 37
 - under control of host computer 19

- upon power up 3

C

- Cables
 - may require modification 39
 - pinouts 40
 - types 2, 40
- Caps Lock 12, 39
- Case opening 42
- CCD Scanners how to use 10
- Character codes reassigning 21
- Characters setup menu parameter 22
- Check Character 46
- Check digit/checksums
 - Code 39 37
 - Interleaved 2 of 5 37
- Check digits/checksums .. 46, 49, 50, 51, 55, 57
 - ACK/NAK protocol 18
 - and Accumulate mode 31
 - Code 128 37, 49
 - Code 39 12, 46
 - Interleaved 2 of 5 16
 - Interleaved 2 of 5 51
 - MSI Code 14
 - UCC/EAN-128 49
 - UPC/EAN 13, 55
- Codabar 48
 - about 48
 - CLSI Format 15
 - default settings 8, 15
 - Start/stop Transmission 15
 - Start/Stop transmission 48
- Code 128
 - about 49
 - default settings 8, 15
- Code 128 Specifications 49
- Code 128 subsets 49
- Code 39 12
 - about 45
 - Accumulate mode 12, 31
 - Caps Lock 12
 - check digits 12, 46
 - default settings 8, 12
 - start/stop transmission 12
- Code 39 Advanced Features and Functions 46

Code 93	
about	59
settings	16
Code 93 Specifications	59
Continuous scanning	30

D

Daisy-chaining readers	6
Data bits	17
Data Format	23, 39
Data transmission format	36
Data Transmission Timing	17
Default settings	8
Delays	17
direct sunlight reading	30
Double-scan checking	30
DTR	41
DTS jumper	44
Duplex - half	39

E

EAN 128	49
EAN/UCC 128	
enabling/disabling	15
EAN-128	
Shipping Serial Container Code	15
Enabling	
2 of 5 Code	16
Codabar	15
Code 128	15
Code 39	12
Code 93	16
MSI/Plessey	14
RSS14	15
UPC/EAN	13
Example host program	
on-line polled with ACK/NAK	35

F

Fast scanning	30
Foreign keyboards	22
Full ASCII Code 39	
about	47
default settings	12
Full ASCII Extension to Code 39	47
Full ASCII hex values	21
Function Keys from PortKey	32

H

Half duplex	
troubleshooting	39
Half Duplex/Full Duplex jumper	43
Hardware handshaking	41
Hex values	21
Host / Terminal configuration	
setting jumper for	43
Host Responce Delay	19

I

ID's for bar code types	15
Incorrect reading	30
Installation	
between computer and terminal	5
connecting scanner and power	
adapter	3
Daisy-chain	6
for polling	6, 33
scanners	3, 27
with dedicated serial port	4
Interleaved 2 of 5	
about	51
check digit calculation	51
check digits	16, 37, 51
data length	37, 51
default settings	16
Interleaved 2 of 5 Code	51
ISBN	14
ISBN Specifications	54

J

Jumper and Switch settings	43
----------------------------------	----

K

Keyboard scan codes	
in preamble/postamble	20
Keyboard scan codes in	
preamble/postamble	60
Keyboards	
different countries	22

L

Laser scanners	
2 and 4 second beams	30
about	27

continuous scanning warning	30
decode light	43
double-scan checking	30
how to use	10
jumper settings	43
types	27
warning labels	28
Leading characters -- trimming	20
Leading digits (UPC/EAN)	13, 53
Leading spaces and Accumulate Mode	31, 38
LED	
and ACK/NAK protocol	19
and polling protocol	19, 34
and scanning	24
and XON/XOFF protocol	18
at power on	3
during configuration	10
if it doesn't light	37
under control of host computer	19
LOGMARS	45
LZ300 laser scanner	27
LZ400 laser scanner	27

M

MagStripe slot scanner	
about	26
setup menu settings	23
Min/max limits on data	21
Modulus 43 Check Characters	46
MSI check digits	14, 57
MSI code - about	57
MSI Code default settings	14
MSI/Plessey code	14, 57
about	14, 57
check digits	14, 57

N

Numeric "Barpad"	31
------------------------	----

O

Opening case	42
--------------------	----

P

Parity	17
Partial reads EAN-13	14

PC-Terminal Mode	
Hex scan codes	60
when to use	23
Plessey code	57
Polled transmission format	36
Polling	18, 33, 35
Portkey	
about	1
testing reader with	24
WDR installation for	4
Postamble	21
Power adapter	
installation	3
troubleshooting	37
WARNING!	2
Preamble	20
Prefix for bar code types	15
Protocol	18

Q

Quiet zones	9, 38, 45
-------------------	-----------

R

reading one bar code among many	30
Reading through a windshield	30
Reassigning character codes	21
Reset	20
RS-232 ASCII data format	23, 39
RSS-14	15

S

Scanner Port	3
Scanning techniques	
CCDs and Lasers	10
slot scanners	25
wands	9
Selective trimming	20
Serial Y Cable	
setting jumper for	43
Set ID Character	15
Setup Menu	
Baud Rate	17
Code 128	15
Code 39	12
Data bits	17
data transmission timing	17
Keyboard country	22
Parity	17
Postamble	21

- Preamble20
- Protocol 18
- Stop bits18
- Terminator Character22
- UPC/EAN13
- Shipping Serial Container Code 15
- Slot scanners9
- Specifications for Code 3945
- Stand for lasers28
- Start/stop characters
 - Codabar15, 48
 - Code 39.....12, 31, 46
 - transmission.....12, 45
- Stop bits18
- Stripping characters
 - leading20
 - trailing21
- Substitutions of data30

T

- Terminator characters22, 34, 38
- Testing the WDR Reader24
- Timing problems.....17
- Trailing character trimming.....21
- Triggerless continuous scanning30
- Trimming Characters
 - leading20
 - trailing21
- Troubleshooting37

U

- UCC-128**
 - about49
 - enabling or disabling15
- UCC-128/ EAN-12849
- UPC Specifications.....53
- UPC/EAN
 - "supermarket scanners"53
 - 2 and 5 digit supplemental codes...54
 - about55
 - Checksum55
 - compressed or expanded13, 38

- default settings..... 13
- guidelines for use..... 53
- ISBN format 14, 54
- NSC's and check digits 13
- numbering conventions 53
- Supplemental codes 8, 13, 53
- UPC-A –adding a country code 13
- UPC-A in 13 digit EAN format 13
- UPC/EAN checksum character*See*
- UPC-E Checksum Calculation 56
- UPC-E1 caution if reading EAN-13... 14
- Using the MagStripe Slot Scanner 26

V

- Vehicle ID reading..... 30

W

- Wand Port 43
- Wand scanners
 - how to use 9
 - infrared..... 38
 - jumper settings..... 43
- Warning labels for laser..... 28
- WDR Reader
 - components of your shipment 1
 - default settings..... 8
 - jumper and switch settings 43
 - opening case 42
- WDR Reader Setup Men
 - terminator character..... 22
- WDR Reader Setup Menu 11
 - 2 of 5 Code 16
 - 2 of 5 Data Length..... 16
 - Data Transmission 17
 - Postamble.....21
 - preamble 20

Y

- Y / S jumper 43